

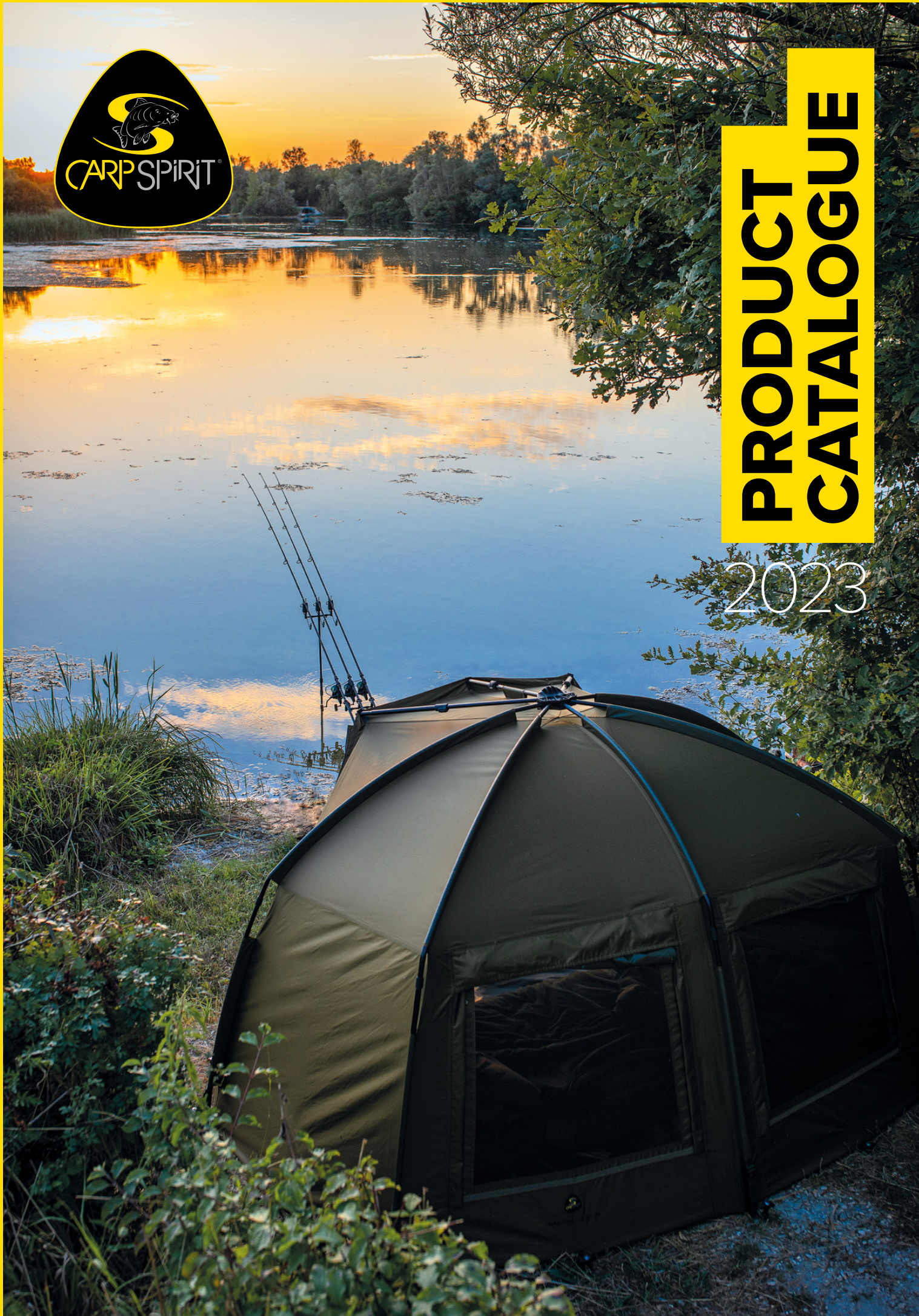

PRODUCT CATALOGUE

2023





CONTENTS

NEW PRODUCTS	02
BEDS & CHAIRS	03-09
SLEEPING BAGS & ACCESSORIES	11-17
LUGGAGE & TRANSPORT	18-26
BIVVIES & SHELTERS	27-39
ALARMS & INDICATORS	40-50
BANKWARE & PODS	51-64
RODS	65-74
LANDING NETS	75-79
CARP CARE & WEIGHING	80-84
BOATS	85-96
HOOKS & READY RIGS	97-104
MAINLINE, LEADERS & HOOKLINKS	105-115
RIG TOOLS	116-120
TERMINAL TACKLE, SWIVELS & LEADS	121-134
PVA & PROTECTION MESH	135-140
BAITING UP	141-145
CLOTHING	146-148
ACCESSORIES	149-151
POINT OF SALE	152-153
INDEX	154-157

Keep up to date with all our news, events and adventures...

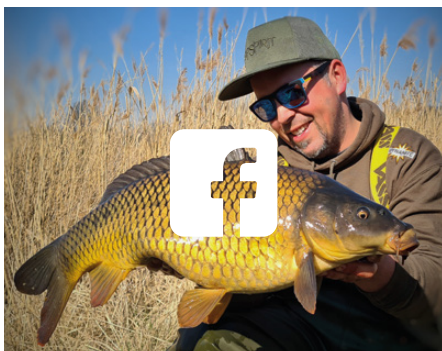

NEW PRODUCTS FOR 2023

BLAX RAZORLITE BIVVY P31



AUTUMN 2022

BLAX RAZORBACK BROLLY P37



AUTUMN 2022

MAGNUM 100 BIVVY P33



AUTUMN 2022

BLAX X-POD SYSTEM P63



EARLY 2023

BLAX CRADLE P81

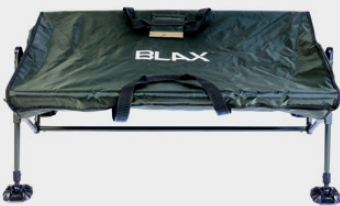

AUTUMN 2022

BLAX X-NET P76



AUTUMN 2022

BLAX REPLACEMENT MESH P79



EARLY 2023

BLAX LANDING NET REPLACEMENT SPREADER BLOCK P79



EARLY 2023

BEDS & CHAIRS

BEDS

- | BLAX BED 06
- | MAGNUM BED 06
- | MAGNUM AIR-LINE BED 07

CHAIRS

- | BLAX LOW CHAIR 08
- | BLAX RELAX CHAIR 08
- | MAGNUM HIGH-BACK CHAIR 09
- | MAGNUM DELUXE CHAIR 09



BEDS

BLAX BED

MAGNUM BED



06



06

Product Code	ACS520035	ACS520031
Key USP	OUTSTANDING VALUE	PERFECTLY FLAT FOR AMAZING COMFORT – 6 LEG OPTION
Frame Material	Steel	Aluminium
Leg Material	Steel	Steel
Powder Coated Frame	●	●
Number of Adjustable Legs	6	6
Self Inflating Air Mattress	—	—
Neoprene Pillow	●	●
Fold Flat In-Line Frame	●	●
Safety Clips	●	●
Dimensions (L/W/H)	210 x 85 x 37-47 cm	210 x 85 x 33-43 cm
Weight	10kg	10.25kg
Maximum Load Rating	125kg	150kg

Recommended Sleeping Bag Size

SIZE STANDARD

SIZE STANDARD

CHAIRS

BLAX LOW CHAIR

BLAX RELAX CHAIR

XL BLAX RELAX CHAIR



08



08



08

Product Code	ACS520039	ACS520038	ACS520037
Key USP	EXCEPTIONAL VALUE	LONG SESSION CHAIR AT A GREAT PRICE – FROM £XX TRADE	
Frame Material	Steel	Steel	Steel
Leg Material	Steel	Steel	Steel
Powder Coated Frame	●	●	●
Number of Adjustable Legs	2	2	2
Neoprene Headrest	—	●	●
Adjustable Backrest	—	●	●
Dimensions	Back Rest (L): 50cm Seat (W): 50cm Seat (H): 33-43cm	Back Rest (L): 65cm Seat (W): 45cm Seat (H): 41-51cm	Back Rest (L): 65cm Seat (W): 50cm Seat (H): 50-60cm
Weight	3.9kg	5.5kg	5.8kg
Maximum Load Rating	120kg	120kg	130kg

XL MAGNUM BED

MAGNUM AIR-LINE BED

XL MAGNUM AIR-LINE BED



06



07



07

ACS520030

ACS520029

ACS520028

PERFECTLY FLAT FOR AMAZING COMFORT – 8 LEG OPTION

ULTIMATE COMFORT – SELF-INFLATING MATTRESS – 6 OR 8 LEG OPTION

Aluminium	Aluminium	Aluminium
Steel	Aluminium	Aluminium
●	●	●
8	6	8
—	●	●
●	●	●
●	●	●
●	●	●
220 x 105 x 37-47 cm	210 x 85 x 33-43 cm	210 x 105 x 37-47 cm
13.25kg	10.5kg	12.5kg
200kg	150kg	200kg

SIZE XL

SIZE STANDARD

SIZE XL

MAGNUM HIGH BACK CHAIR

MAGNUM DELUXE CHAIR

XL MAGNUM DELUXE CHAIR



09



09



09

ACS520034

ACS520033

ACS520032

EXTREMELY COMFORTABLE & ADJUSTABLE

OUR ULTIMATE CHAIR – OPTIMUM COMFORT

Steel	Aluminium	Aluminium
Steel	Aluminium	Aluminium
●	●	●
4	4	4
●	●	●
●	●	●
Back Rest (L): 80cm Seat (W): 55cm Seat (H): 40-55cm	Back Rest (L): 70cm Seat (W): 50cm Seat (H): 38-51cm	Back Rest (L): 70cm Seat (W): 65cm Seat (H): 38-51cm
6.9kg	6.4kg	6.9kg
130kg	140kg	160kg

BLAX BED

- Entry level bed that offers exceptional performance and value.
- The high-density foam filled mattress and fold flat steel frame, results in a highly durable bed that provides a fantastic night's comfort.
- All legs are fully adjustable to combat the most unaccommodating of bankside locations.

Perfect size for use with all our standard size sleeping bags (see pages 11 to 17).



THE DETAIL

- ① High density foam filled mattress and perimeter.
- ② Low-profile neoprene pillow.
- ③ Fold flat steel frame.
- ④ Fully adjustable legs with auto lock adjustment.
- ⑤ 6x swivelling mud-feet.

OUTSTANDING VALUE!



MAGNUM BED

- A feature packed bed that meets the needs of the most dedicated angler.
- Built on a lightweight fold flat Aluminium frame, and incorporating a hollow fibre filled central mattress, the Magnum Bed is highly durable and offers excellent thermal efficiency and comfort.
- Fully adjustable legs with auto lock adjustment to combat the most unaccommodating of bankside locations.
- Available in 2 sizes.

PERFECTLY FLAT FOR AMAZING COMFORT

Perfect size for use with all our standard size sleeping bags (see pages 11 to 17).



THE DETAIL

- ① Hollow fibre filled mattress.
- ② Low-Profile neoprene pillow.
- ③ Lightweight Aluminium fold flat frame.
- ④ CamoSkin™ perimeter.
- ⑤ Side carry handles.
- ⑥ Fully adjustable legs with auto lock adjustment.
- ⑦ 360° articulated mud-feet.



MAGNUM AIR-LINE BED

- Flagship bed that incorporates a self-inflating mattress for ultimate thermal efficiency and unsurpassed comfort.
- Featuring the same fold flat lightweight Aluminium frame as the standard Magnum Bed, the Airline version is highly durable and will provide years of exceptional bankside comfort.
- Fully adjustable legs with auto lock adjustment to combat the most unaccommodating of bankside locations.
- Available in 2 sizes.



Perfect size for use with all our standard size sleeping bags (see pages 11 to 17).



THE DETAIL

- 1 Self-inflating air mattress*.
- 2 Low-Profile neoprene pillow.
- 3 Lightweight Aluminium fold flat frame.
- 4 CamoSkin™ perimeter.
- 5 360° articulated mud-feet.
- 6 Side carry handles.
- 7 Fully adjustable legs with auto lock adjustment.



Locking valve



SIZE STANDARD



SIZE XL

*To inflate, simply open the valve and let the mattress inflate. Close the valve to hold air during use. To deflate, open the valve and fold the bed flat.

BED CHAIR TABLE

- Lightweight table that is compatible with 22mm profile beds and chairs.
- Perfect storage area for all accessories you need to hand.



CODE	SIZE (CM)	WEIGHT (KG)	MAX LOAD (KG)	BARCODE	TRADE PACK
BLAX BED					
ACS520035	210 x 85 x 37-47	10	125		1
MAGNUM BED					
ACS520030 (XL)	220 x 105 x 37-47	13.25	200		1
ACS520031 (STD)	210 x 85 x 33-43	10.25	150		1
MAGNUM AIR-LINE BED					
ACS520028 (XL)	220 x 105 x 37-47	12.5	200		1
ACS520029 (STD)	210 x 85 x 33-43	10.5	150		1
BED CHAIR TABLE					
374001361	40 x 18	0.52	-		1

BLAX LOW CHAIR

- The perfect short session or guest chair.
- This compact, lightweight low chair offers exceptional value and performance.

THE DETAIL

- ① Foam padded mattress.
- ② Powder coated steel frame.
- ③ 4x fully adjustable legs with auto lock adjustment.
- ④ 4x swivelling mud-feet.



BLAX RELAX CHAIR

- A fantastic value hi-back chair.
- Featuring an adjustable back system, x2 fully adjustable legs and swivel mud feet, the chair is perfect for all terrains.
- Available in 2 sizes – XL and Standard.

THE DETAIL

- ① Neoprene padded upper mattress.
- ② High density foam filled mattress and perimeter.
- ③ Hi-Impact moulded ergonomic arms rests.
- ④ Multi angle position lock.
- ⑤ Powder coated steel frame.
- ⑥ 2x fully adjustable legs with auto lock adjustment.
- ⑦ 2x swivelling mud-feet.

BEST SELLER



MAGNUM HI-BACK CHAIR

- Hi-back style chair that offers fantastic comfort and lumbar support.
- Featuring multi angle position locks and full leg adjustment, this chair is perfect for the most demanding of bank side settings.

THE DETAIL

- ① Hi-back support with multi angle position lock.
- ② Neoprene padded upper mattress.
- ③ High density foam.
- ④ Hi-impact moulded ergonomic arms rests.
- ⑤ CamoSkin™ perimeter.
- ⑥ Aluminium / steel frame.
- ⑦ 4x fully adjustable legs with auto lock adjustment.
- ⑧ 4x 360° articulated mud-feet.



MAGNUM DELUXE CHAIR

- Sets the standard for bankside comfort.
- Featuring a fully adjustable back rake system, neoprene padded arms and head rest, and a thermoformed anti-slip mattress, this fully adjustable chair is the perfect solution for anglers looking for luxury on any terrain.
- Available in 2 sizes – XL and Standard.

THE DETAIL

- ① Neoprene padded upper mattress.
- ② Fully adjustable back rake system.
- ③ Neoprene padded armrest.
- ④ CamoSkin™ perimeter with high density foam padding.
- ⑤ Lightweight Aluminium frame.
- ⑥ Non reflective powder coated frame.
- ⑦ Fully adjustable legs with auto lock adjustment.
- ⑧ 4x 360° articulated mud-feet.



CODE	SIZE (CM)	WEIGHT (KG)	MAX LOAD (KG)	BARCODE	TRADE PACK
BLAX LOW CHAIR					
ACS520039	83-93 x 50	3.9	120		1
BLAX RELAX CHAIR					
ACS520037 (XL)	115-125 x 55	5.8	130		1
ACS520038 (STD)	106-116 x 45	5.5	120		1
MAGNUM HI-BACK CHAIR					
ACS520034	120-135 x 55	6.9	130		1
MAGNUM DELUXE CHAIR					
ACS520032 (XL)	108-121 x 65	6.9	160		1
ACS520033 (STD)	108-121 x 50	6.4	140		1

TAKING CARE OF TACKLE



SEE PAGE 24
FOR MORE
INFORMATION.

HYDRO

A full range of bags and boxes to keep tackle dry, neat, tidy and organised.

- 6 models available (2 bags and 4 boxes)
- Waterproof EVA material
- Welded seam construction
- Double zipper easy access lid
- Bags – Impact resistant moulded waterproof base and lid
- Boxes – UV Resistant smoked lid



SLEEPING BAGS & ACCESSORIES

SLEEPING BAGS

- | BLAX 3 SEASON 14
- | MAGNUM 4 SEASON 15
- | MAGNUM 5 SEASON 16
- | MAGNUM THERMAL BED COVER 17

ACCESSORIES

- | HALF MOON PILLOW 17



SLEEPING BAGS

Being comfortable on the bank is a must – The more comfortable you are, the better you'll fish... and this will ultimately contribute to your success rate. Here at Carp Spirit we take bankside comfort very seriously, so when we developed a complete new range of Magnum and BLAX Sleeping bags and covers, there was a huge focus on research, development and testing to ensure that the finished range of products are the very best available on the market, yet still offer excellent value for money. Rather than just develop a new range of sleeping bags in isolation, we actually designed them as a parallel development alongside the all new Magnum and BLAX beds. The end result is a superb synergy between both our Sleeping bags and beds that uses a simple 2 sizing system:



So whether you're fishing summer nights under a brolly, or a winter session in sub-zero temperatures, you can be sure that there's a Carp Spirit sleeping bag with the performance to meet your requirements that will keep you comfortable and warm during your session.

BLAX 3 SEASON SLEEPING BAG

MAGNUM 4 SEASON SLEEPING BAG



14



15

Product Code	ACS520044	ACS520043
Key USP	EXCEPTIONAL VALUE	FANTASTIC ALL SEASON SLEEPING BAG
Min Temp Rating	0°	-10°
Filling	Silicon Treated 3 Season Hollow Fibre	Silicon Treated 4 Season Hollow Fibre
Outer	Water Resistant 190T Polyester	Waterproof Rip Stop Polyester
Inner	190T Polyester	Micro Fleece Upper – Polyester Lower
Detachable Centre Layer	—	—
Oval Face Cut Out	●	●
10mm Heavy Duty Crash Zips	●	●
Internal & External Zip Baffles	●	●
3 Point Bed Attachment	●	●
Compression Stuff Sack	●	●
Thermal Foot Pocket	●	●
Pillow Retention Draw Cord	●	●
Mesh Side Storage Pockets	—	●
Recommended Sleeping Bag Size	SIZE STANDARD	SIZE STANDARD



XL MAGNUM 4 SEASON SLEEPING BAG

MAGNUM 5 SEASON SLEEPING BAG

XL MAGNUM 5 SEASON SLEEPING BAG

MAGNUM THERMAL BED COVER



15



16



16



17

ACS520042

ACS520041

ACS520040

ACS520045

FANTASTIC ALL SEASON SLEEPING BAG

THE ULTIMATE IN COMFORT, WARMTH AND FLEXIBILITY

FANTASTIC ADDITIONAL LAYER

-10°

-20°

-20°

10°

Silicon Treated 4 Season Hollow Fibre

Silicon Treated 5 Season Hollow Fibre

Silicon Treated 5 Season Hollow Fibre

Silicon Treated Hollow Fibre

Waterproof Rip Stop Polyester

Waterproof Rip Stop Polyester

Waterproof Rip Stop Polyester

Water Resistant Peachskin

Micro Fleece Upper – Polyester Lower

Micro Fleece Upper – Polyester Lower

Micro Fleece Upper – Polyester Lower

Micro Fleece

—

●

●

—

●

●

●

—

●

●

●

—

●

●

●

—

●

●

●

4 Clips

●

●

●

—

●

●

●

—

●

●

●

—

●

●

●

—

SIZE XL

SIZE STANDARD

SIZE XL

SIZE ALL

**UNSURPASSED COMFORT
AT EXCEPTIONAL
PRICE POINTS.**

**EXCEPTIONAL
VALUE!**

BLAX 3 SEASON

- Offers fantastic value and performance plus a host of features normally associated with sleeping bags twice the price.
- Ideal for use in Spring, Summer or Autumn, thanks to its 3-season silicone treated hollow fibre filling; it offers excellent insulation yet is still lightweight and practical.
- **Filling:** 3 season Hollow Fibre filling with silicone treatment for increased volume & longevity.
- **Outer:** Water resistant 190T polyester.
- **Inner:** Smooth micro weave polyester.



Large neck baffles to keep you warm.



10mm heavy-duty crash zips.



MIN TEMP
0°C ❄️



Supplied in stuff sack.

THE DETAIL

- ① Oval cut out – Allows you to be fully zipped in for maximum warmth.
- ② Closely spaced full length panel stitching.
- ③ Side zips stop short at the base to creating a thermal pocket around your feet.
- ④ Draw cord base.
- ⑤ Oversized external/internal zip baffles.
- ⑥ Hooded pillow retention draw cord.



Oversized head to secure to bed.



Velcro leg cut outs to help secure to bed.

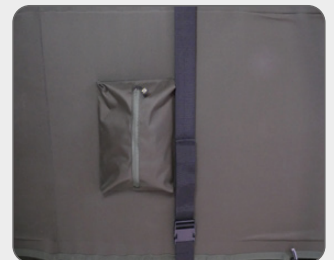

Central securing strap.

Perfect with our range of beds: Pages 06-07.

MAGNUM 4 SEASON

- A true all-season bag that provides outstanding performance thanks to its 4 season silicone treated Hollow Fibre filling.
- The unique 50/50 lining uses Micro fleece around the head and body area, which is instantly warm to the touch, whilst the lower part of the bag is made using smooth rip stop material to reduce the chances of the bag pulling and catching on your legs.
- **Filling:** 4 season Hollow Fibre filling with silicone treatment for increased volume & longevity.
- **Outer:** Waterproof Rip-Stop Polyester outer fabric.
- **Inner:** Unique 50/50 lining – Micro fleece upper / Smooth Rip-Stop polyester lower.



SIZE STANDARD



SIZE XL

MIN TEMP -10°C ❄️

Perfect with our range of beds: Pages 06-07.

THE DETAIL

- 1 Oval cut out – Allows you to be fully zipped in for maximum warmth.
- 2 Closely spaced full length panel stitching.
- 3 Velcro base – XL / Draw cord base – Standard.
- 4 Side zips stop short at the base to creating a thermal pocket around your feet.
- 5 Oversized external/internal zip baffles.
- 6 Hooded pillow retention draw cord.



Large neck polar fleece baffles to keep you warm.



10mm heavy-duty crash zips.



Velcro leg cut outs to help secure to bed.



Supplied in stuff sack.



Zipped mesh pockets on both sides.



Oversized head to secure to bed.



Central securing strap.

CODE	SIZE (CM)	MINIMUM TEMP RATING	BARCODE	TRADE PACK
BLAX 3 SEASON				
ACS520044	220 x 95	0°		1
MAGNUM 4 SEASON				
ACS520042 (XL)	230 x 115	-10°		1
ACS520043 (STD)	220 x 95	-10°		1

MAGNUM 5 SEASON

- Sets a new standard in bankside comfort, even when fishing in the most extreme conditions.
- Featuring a 5 Season silicone treated Hollow Fibre filling and a detachable central layer, it is incredibly versatile allowing extra warmth to be added or removed as the temperature changes throughout the year.
- **Filling:** 5 Season Hollow Fibre filling with silicone treatment for increased volume & longevity.
- **Outer:** Waterproof Rip-Stop Polyester outer fabric.
- **Inner:** Unique 50/50 lining – Micro fleece upper / Smooth Rip-Stop polyester lower.



SIZE STANDARD

Perfect with our range of beds: Pages 06-07.



SIZE XL

MIN TEMP -20°C ❄️

THE DETAIL

- 1 Fully detachable centre layer.
- 2 Oval cut out – Allows you to be fully zipped in for maximum warmth.
- 3 Closely spaced full length panel stitching.
- 4 Velcro base – XL / Draw cord base – Standard.
- 5 Side zips stop short at the base o creating a thermal pocket around your feet.
- 6 Oversized external/internal zip baffles.
- 7 Hooded pillow retention draw cord.



Large neck polar fleece baffles to keep you warm.



10mm heavy-duty crash zips.



Velcro leg cut outs to help secure to bed.



Supplied in stuff sack.



Zipped mesh pockets on both sides.



Oversized head to secure to bed.



Central securing strap.

**DETACHABLE CENTRE LAYER
ALLOWS YOU TO CONVERT THE
MAGNUM 5 SEASON SLEEPING
BAG INTO A 4 SEASON VERSION
IN WARMER TEMPERATURES.**

**THE ULTIMATE
IN COMFORT,
WARMTH AND
FLEXIBILITY**



MAGNUM THERMAL BED COVER

- Versatile cover that is fully breathable so can be used on its own just like a duvet, ideal for warm summer nights; or it can be an additional layer for your existing bag to further increase insulation in the winter months.
- 4 connection points – can be used in 'poncho style' by propping up.
- 2 small corner pockets.
- **Filling:** Hollow Fibre filling with silicone treatment for increased volume & longevity.
- **Outer:** Water resistant peach-skin polyester.
- **Inner:** Micro polar fleece.
- Fit Standard and XL bed.



Perfect with our range of beds: Pages 06-07.



MIN TEMP
10°C ❄️

HALF MOON PILLOW

- The perfect pillow with the perfect shape – specially designed to fit sleeping bags.
- Fully reversible: featuring a micro fleece covering on one side that's instantly warm to the touch and ideal for the winter use, and a cool peach skin fabric on the other, perfect for the summer.
- Fits both Standard and XL Carp Spirit Sleeping Bags.



CODE	SIZE	MINIMUM TEMP RATING	BARCODE	TRADE PACK
MAGNUM 5 SEASON				
ACS520040 (XL)	230 x 115	-20°		1
ACS520041 (STD)	220 x 95	-20°		1
MAGNUM THERMAL BED COVER				
ACS520045	220 x 95	10°		1
HALF MOON PILLOW				
ACS520046	85 x 55	–		1

LUGGAGE & TRANSPORT

LUGGAGE

ROD HOLDALLS

- | MAGNUM 13FT ROD HOLDALL 19
- | RIGID BAG 20
- | SOFT SLEEVE 20
- | MULTI SLEEVES 20
- | ROD SLEEVE 20
- | ROD END PROTECTOR 21
- | ROD HOLDER 21

CARRYALLS

- | MULTI CARRYALL 22
- | MAGNUM CARRYALL M/L/XL 22
- | BAG & LARGE BOXES 23
- | BAIT BAG 23
- | MINI CARRYALL 23
- | WATERPROOF BOX 23

ACCESSORY BAGS

- | HYDRO LUGGAGE 24
- | BANKSTICK & BUZZ BAR BAG 24
- | ENDURO CASE 25
- | LEAD CASE 25
- | SPOOLS CASE 25
- | CAMPING SET 25
- | CAMPING SET DELUXE 25

TRANSPORT

BARROWS

- | MONSTER BARROW 26



MAGNUM 13FT 4 ROD HOLDALL

- Maximum protection for rods and reels.
- Collapsible Aluminium spine included for additional support.
- Moulded rigid shells for maximum reel protection.
- 2 external pockets:
 - 1 long pocket for umbrella/landing net.
 - XL bank stick pocket.
- Reinforced heavy duty base.
- EVA carry handles and fully adjustable EVA shoulder strap.
- Capacity: 4x 12/13' rods with reels + 4 rods without reels.



CODE	SIZE (CM)	RODS (FT)	WEIGHT (KG)	BARCODE	TRADE PACK
MAGNUM 13FT 4 ROD HOLDALL					
ACS070058	42 (52) x 220	13 (4 Rods)	5.50		1

RIGID BAG

- Rigid support bag for ultimate protection of your rods and reels.
- 2 separate compartments to accommodate 2 rods (with 50mm rings).
- Features outer storage pocket for accessories.
- EVA carry handle and fully adjustable EVA shoulder strap.
- Available in 2 sizes: 13'/210cm and 10'/175cm.



13ft

10ft

MAGNUM MULTI SLEEVE

- Maximum protection for rods and reels due to thick padded internal dividers.
- Single zip to main compartment for quick access.
- Fully adjustable and padded nonslip EVA shoulder strap.
- Landing net handle will attach to the outside to act as a spine.
- Will accept 50mm butt guides.



13ft 3 Rod

13ft 5 Rod

12ft 5 Rod

10ft 4 Rod

MAGNUM SOFT SLEEVE (SINGLE)

- Maximum protection individual rod sleeve with central divider.
- Will accept 50mm butt guides.
- EVA carry handle.
- Access zip located on the opposite side of reel to prevent catching and damage to mainline or braid.
- Stitched in hanging loop.



13ft

12ft

10ft

ROD SLEEVE (SINGLE)

- Individual rod sleeve with central partition.
- EVA carry handle.
- Access zip located on the opposite side of reel to prevent catching and damage to mainline or braid.



13ft

12ft

10ft

ROD END PROTECTOR

- Two per pack (butt and tip).
- Adjustable Velcro fastener.

**ROD HOLDER**

- Neoprene end protector for rods during transport and storage.
- Velcro fastener to adjust the tightening.
- 2 per pack (Small - for the tip, Large – for the butt section).



CODE	SIZE (CM)	RODS (FT)	WEIGHT (KG)	BARCODE	TRADE PACK
RIGID BAG					
ACS070006	27 x 220	13	3.10		1
ACS070020	27 x 175	10	2.70		1
MAGNUM SOFT SLEEVE					
ACS070050	24 x 220	13	0.95		1
ACS070049	24 x 205	12	0.90		1
ACS070048	24 x 175	10	0.75		1
MAGNUM MULTI SLEEVE					
ACS070051	35 x 220	13 (3 rods)	1.75		1
ACS070052	35 x 220	13 (5 rods)	2.40		1
ACS070077	35 x 205	12 (5 rods)	2.20		1
ACS070075	35 x 175	10 (4 rods)	1.75		1
ROD SLEEVE					
299001360	24 x 220	13	0.95		1
124400360	24 x 205	12	0.90		1
147700360	24 x 175	10	0.76		1
ROD END PROTECTOR					
125400360	—	—	0.10		1
ROD HOLDER					
714001361	26 & 15	—	0.10		1



MULTI CARRYALL

BEST SELLER

- Constructed using a folding Aluminium frame, it is perfect for terminal tackle and accessory storage.
- When open, the folding top section unveils 2 quick access pockets. When in this position, the central section can also act as a workstation / table.
- The carryall is supplied with 2 large storage boxes (in large base pocket), 1 medium store box (inside folding pocket) and 3 small storage boxes (inside folding pocket).



EXTREMELY VERSATILE CARRYALL



MAGNUM CARRYALL

- Large main compartment, perfect for clothes or large accessories.
- 2x padded side zip pockets, and 2x end quick access pockets, perfect for accessories.
- Fully padded main front pocket is compatible with large Carp Spirit tackle boxes.
- Additional padded front pocket on the XL size.
- EVA carry handles and fully adjustable EVA shoulder strap.
- Heavy duty reinforced base.
- 3 sizes: M / L / XL.



Large



Medium



BAG AND LARGE BOXES

- Multi compartment bag for maximum storage.
- Supplied with x2 large storage boxes, perfect for small accessories and terminal tackle.
- Aluminium framework for reinforcement.



MINI CARRYALL

- Multi compartment carryall perfect for short sessions.
- Padded shoulder strap and carry handle.
- EVA moulded base.



BAIT BAG

- A fully insulated bait bag that can hold up to 4kg of boilies.
- Featuring a removable top section that is ideal for storing glugged baits and pop ups.
- Padded shoulder strap and carry handle.
- EVA moulded base.
- 8 hook bait pots included.



WATERPROOF BOX

- Waterproof storage case for all valuable equipment and accessories.
- Automatic pressure equalization valve.
- Easy opening with a double lever system.
- Double hole for padlock.



CODE	SIZE (CM)	WEIGHT (KG)	BARCODE	TRADE PACK
MULTI CARRYALL				
ACS070008	40 x 24 x 32	3.50		1
MAGNUM CARRYALL				
ACS070053 (M)	60 x 36 x 36	1.90		1
ACS070054 (L)	70 x 36 x 40	2.25		1
BAG AND LARGE BOXES				
125800360	50 x 35 x 34	3.0		1
BAIT BAG				
ACS070069	30 x 30 x 26	1.2		1
MINI CARRYALL				
692001361	45 x 32 x 28	1.31		1
WATERPROOF BOX				
ACS140010	34 x 30 x 15	1.75		1



CARP SPIRIT'S RANGE OF WATERPROOF HYDRO LUGGAGE IS PERFECT FOR KEEPING ITEMS OF TACKLE NEAT, TIDY, ORGANISED AND DRY DUE TO ITS TECHNICALLY ADVANCED WELDED SEAM CONSTRUCTION. WHETHER ON THE BANK, OR ON THE MOVE, THE HYDRO LUGGAGE IS THE PERFECT TRANSPORT OPTION FOR ALL YOUR TACKLE AND ACCESSORY NEEDS.

HYDRO BOXES

BEST SELLER

- 4 models available; 122, 126, 213, 343.
- Waterproof material with welded seam construction.
- EVA 0.85mm body & 1.5mm bottom.
- UV Resistant smoked lid.
- * Mesh pocket lid insert (343 model only).



* Mesh pocket lid insert (343 model only).

HYDRO BAGS

- 2 models available: 2600 or 3520.
- Waterproof material with welded seam construction.
- EVA 1.5mm body.
- Impact resistant 1 piece moulded waterproof base and lid.
- Anti-Slip base.



Adjustable shoulder strap (2600 model). Side clasp handle carry straps (3520 model).

BANKSTICK & BUZZ BAR BAG

- Ultimate protection for bank sticks and buzz bars.
- Padded centre divider.
- Velcro and elastic fixing points for secure fit.
- Alarms can be left on top of the Buzz bars.
- Available in 2 sizes: Standard and XL.



ENDURO CASE

- Multi feature storage case perfect for terminal tackle and small items.
- Includes x3 small storage boxes and one storage tube.



SPOOL CASE

- Heavy duty spool case that offers maximum protection.
- Designed to store 4 spare spools.



LEAD CASE

- Multi-purpose storage case which has primarily been designed for leads.
- Reinforced seams and zippers.
- Neoprene handle.



CAMPING SET

- Set featuring: 2 plates, 2 forks, 2 knives, and 1 small towel.



CAMPING SET DELUXE

- Contains 2 plates, 2 forks, 2 knives, 2 spoons, 2 cups and 1 thermos flask and 2 small towels.



CODE	SIZE (CM)	CAPACITY (L)	WEIGHT (KG)	BARCODE	TRADE PACK
HYDRO BOXES					
ACS140014 (122)	14 x 12.5 x 7	1.22	—		1
ACS140015 (126)	20 x 9 x 7	1.26	—		1
ACS140016 (213)	21 x 14.5 x 7	2.13	—		1
ACS140017 (343)	24.5 x 17.5 x 8	3.43	—		1
HYDRO BAGS					
ACS140018 (2600)	40 x 26 x 25	26.00	—		1
ACS140019 (3520)	45 x 29 x 27	35.20	—		1
BANKSTICK & BUZZ BAR BAG					
ACS370088 (STD)	45 x 18 x 5	—	—		1
ACS370089 (XL)	65 x 18 x 5	—	—		1
ENDURO CASE					
125500360	22 x 16 x 6	—	—		1
LEAD CASE					
292001360	8 x 22 x 8	—	0.27		1
SPOOL CASE					
293001360	18 x 18 x 9	—	0.18		1
CAMPING SET					
987000361	26 x 24	—	0.82		1
CAMPING SET DELUXE					
ACS010183	31 x 25 x 10	—	1.86		1



THE CARP SPIRIT MONSTER BARROW IS TRUE TO ITS NAME WITH A HUGE LOAD CAPACITY THAT HAS BEEN TRIED AND TESTED WITH LOADS IN EXCESS OF 100KG.

**BIG LOAD,
BIG TERRAIN,
BIG VALUE!**

MONSTER BARROW

- Fully removable handles and wheels – fold flat design.
- Extendable V front support with safety stop marks – provides front support for long rod holdalls.
- Seam welded & reinforced Aluminium framework.
- Nonslip rubber hand grips.
- 2x 360-degree mud feet as standard.
- Oversized deep tread tyres to pass thought the roughest of terrain.
- Supplied with 4x hook tensioners to secure the load.
- Tailored fit Barrow carryall included which can be removed by clips.



Spare Wheel (ACS070072)



2 Wheel Configuration

CODE	WIDTH (CM)	LENGTH EXTENDED (CM)	LENGTH CLOSED (CM)	WEIGHT (KG)	BARCODE	TRADE PACK
MONSTER BARROW						
ACS070071	80	126	106	18		1
MONSTER BARROW SPARE WHEEL						
ACS070072	—	—	—	TBC		1

BIVVIES & SHELTERS

BIVVIES

| BLAX BIVVY 30

NEW | BLAX RAZORLITE BIVVY 31

NEW | MAGNUM 100 33

| EVEREST 1 MAN 34

| MINI DOLMEN 35

| OUTHOUSE 36

SHELTERS

NEW | BLAX RAZORBACK BROLLY 37

| S.C.S+ 38

| SPEED-R 39

BIVVY & OVERNIGHT ACCESSORIES

| BIVVY TABLE 40

| 12 PEGS AND MALLET 40

| CORD 15M 40

| PORTABLE SHOWER 40

| FOLDING SHOVEL 40

| BLAX STORM POLES 40

BIVVIES & SHELTERS

BLAX 1
MAN BIVVY



30

BLAX 2
MAN BIVVY



30

BLAX RAZORLITE
BIVVY



31

MAGNUM
100 BIVVY



33

Product Code	ACS540049	ACS540051	ACS540057	ACS540055
Key USP	EXCEPTIONAL PERFORMANCE AND VALUE		THE PERFECT ALLROUND BIVVY	OUR HIGHEST PERFORMANCE BIVVY
Dimensions (cm)	275 x 140 x 205	320 x 160 x 290	280 x 140 x 190	250 x 140 x 185
Weight (kg)	8	10	4.2	7.5
Capacity	1+	2+	1	1
Hydro-Skin Fabric				●
Arma-Skin Fabric				
PU Fabric 200D			●	
PU Fabric 210D	●	●		
Hydrostatic Head mm2	5,000	5,000	8,000	20,000
Breathable				
Half winterskin included				
Double entry				
Velcro Rod supports	●	●	●	●
Winter Skin Available	●	●	●	
Reinforced zips	●	●	●	●
Thermo-Welded seams	●	●	●	●
Transparent window(s)	●	●		
Mosquito mesh window(s)	●	●	●	●
Vented Roof with Mosquito Mesh				
Rear Panel Vents	●	●		●
Removable front panel			●	●
Aluminium Frame	●	●	●	●
Fibreglass Frame				
Storm poles included				●
Heavy Duty Groundsheet				●
PE Groundsheet	●	●	●	
Moulded screw pegs	●	●	●	●
Carry bag	●	●	●	●



**EVEREST
1 MAN**

**MINI
DOLMEN**

OUTHOUSE / XL

**BLAX RAZORBACK
BROLLY**

SCS+

SPEED-R



34

35

36

37

38

39

ACS540046	ACS540039	ACS540035/36	ACS540059	ACS540054	ACS540043
SUPER STRONG AND LIGHT FRAME	FEATURE PACKED COMPLETE WITH WINTER SKIN	SPACIOUS MULTI USE BIVVY	INCREDIBLE VALUE AND PRICE	SUPER COMPACT AND PORTABLE	QUICK & EASY ERECT
260 x 142 x 240	260 x 180 x 300	220 x 210 x 150 220 x 220 x 250	270 x 180 x 200	220 x 120 x 120	290 x 150 x 230
15	19	14.6 / 18.5	4.5	5.4	15.5
1+	1+	1	1	1	1
●	●			●	●
		●	●		
10,000	10,000	5,000	8,000	10,000	10,000
●	●			●	●
	●				
●	●	●			●
●	●		●		●
●	●	●	●	●	●
●	●	●	●	●	●
●	●	●	●	●	●
●	●	●	Additional Purchase	●	●
●	●			●	●
●			Additional Purchase		●
●	●	●	●		●
		●	●	●	●
●	●	●	●	●	●
●	●	●	●	●	●
●	●	●	●	●	●



BLAX™ BIVVY



**EXCEPTIONAL
PERFORMANCE
AND VALUE**

**BEST
SELLER**



Winterskin

- Constructed using tough & durable 210D PU backed nylon (5,000mm² hydrostatic head), with thermally taped seams throughout.
- 2-rib design Aluminium main frame is lightweight and features a front porch peak – perfect for when fishing the front door letter box style.
- Sides mosquito vents can be used by simply rolling back the covers.
- The front door features 3 options of closed, PVC or Mosquito mesh.
- The front itself can be completely rolled back and clipped into place to provide maximum visibility of the lake.
- Durable lightweight PU groundsheet, heavy duty moulded 'T' pegs, and oversized carry bag included.
- Available in 1- and 2-man options
- A full Winter Skin is also available separately for both sizes for added comfort in the most extreme conditions.

CODE	DIMENSIONS W/H/D (CM)	WEIGHT (KG)	BARCODE	TRADE PACK
BLAX 1 MAN				
ACS540049	275 x 140 x 205	8.0		1
ACS540050 (Winterskin)	—	3.4		1
BLAX 2 MAN				
ACS540051	320 x 160 x 290	10.0		1
ACS540052 (Winterskin)	—	4.1		1

BLAX

RAZORLITE BIVVY

NEW AUTUMN 2022

BIVVIES & SHELTERS

LIGHT & FAST BUILD



Full Bivvy



Winterskin



Letterbox



Shelter



- A lightweight bivy that can be configured to suit a host of different situations. Fish without the front as a day shelter for short sessions or when on the move, add the front to become a bivvy, or add the winterskin for extreme weather conditions.
- Constructed using tough and durable 200D Nylon PU Fabric (8000mm² Hydrostatic Head), and 7001 Aerospace grade flexible Aluminium poles, the Razorlite is the ultimate lightweight bivvy.
- Zip in front panel and be fully removed or rolled and clipped back.

- Solid center door with mosquito mesh – can be fished 'letter box' style.
- Thermally taped seams throughout.
- Velcro rod straps.
- Medium weight PVC groundsheet, heavy duty molded 'T' pegs, and oversized carry bag included.
- A full Winter Skin is also available separately for added comfort in the most extreme conditions.

CODE	DIMENSIONS W/H/D (CM)	WEIGHT (KG)	BARCODE	TRADE PACK
BLAX RAZORLITE BIVVY				
ACS540057	280 x 140 x 190	4.2		1
ACS540058 (Winterskin)	—	1.1		1

BLAX | VX-R



INCREDIBLE PERFORMANCE, INCREDIBLE PRICE.

FOR MORE INFORMATION
SEE PAGE 45.



FEATURES INCLUDE:

- 4 volume levels, plus silent setting.
- 4 tone settings.
- 4 levels of sensitivity.
- Hi-Viz blue LED's.
- 20 second latching LED.
- Night light mode.
- Low battery warning.
- Range up to 150m.
- 2.5mm power out socket.
- Protection case included.



SET OF 3+1



SET OF 4+1



MAGNUM 100 BIVVY



NEW AUTUMN 2022



Camo Zip in Mozzi Mesh.



- The feature packed Magnum 100 bivvy is constructed using a 2-piece 360-degree centre block that enables rapid setup and pack down.
- The lightweight aluminium frame with individual leg tension bungees, and moulded elbow joints, ensures reliability and confidence even in the harshest of conditions.
- Wrapped in our high-performance HYDRO-SKIN material (20,000mm² Hydrostatic Head) that features black out technology, the bivvy is the perfect option for harsh winters and light summer mornings.
- The flat back design allows beds to be placed towards the back creating more useable floor space and increased headroom.
- Additional features include; height adjustable splay frame design, 2x Rear Mosquito vents, thermally taped seams throughout, Velcro rod straps, zip off front infill panel (infill panel sides can also be rolled and clipped back), solid centre door with mosquito mesh - can be fished 'letter box' style, internal mesh storage pockets.
- Heavy duty groundsheet, heavy duty storm poles, heavy duty Moulded 'T' pegs and oversized carry bag included.
- Camo Mosquito Mesh full zip front Panel available separately.

CODE	DIMENSIONS W/H/D (CM)	WEIGHT (KG)	BARCODE	TRADE PACK
MAGNUM 100 BIVVY				
ACS540055	250 x 140 x 185	7.5		1
MAGNUM 100 BIVVY ZIP-IN MOZZI MESH				
ACS540056	—	—		1

EVEREST 1 MAN



SUPER STRONG
AND LIGHTWEIGHT
FRAME



Winterskin



- The Everest 1 man bivy is both quick and easy to erect.
- Constructed using ARMA-SKIN™ fabric (10,000mm² Hydrostatic Head), on a 4 rib Aluminium frame, it is incredibly strong and stable.
- The extended front rib provides additional protection and cover over the door area from the elements, particular useful for when using the front door 'letterbox' style.

- The fully removable front panel features side mosquito meshes and a multi-configuration door that can be used in closed, mosquito, or clear PVC window.
- Rear mosquito vents have also been added for increased ventilation and velcro rod support straps have been added to the frame as standard.
- Heavy duty groundsheet, heavy duty moulded 'T' pegs, and oversized carry bag included.
- A full Winter Skin* is also available separately for added comfort in the most extreme conditions.

* Will accept two Beds with front panel removed and Winter skin fitted. Mini porch groundsheet supplied to be used for this configuration.

CODE	DIMENSIONS W/H/D (CM)	WEIGHT (KG)	BARCODE	TRADE PACK
EVEREST 1 MAN				
ACS540046	260 x 142 x 240	15.0		1
ACS540047 (Winterskin)	—	7.5		1

MINI DOLMEN



ALL SEASON
SUPPLIED WITH
HALF WINTERSKIN



- Featured packed bivvy, perfect for long sessions on the bank.
- Constructed using ARMA-SKIN™ fabric (10,000mm² Hydrostatic Head), on a unique Aluminium frame design, the Mini Dolmen offers a spacious bivvy that is incredibly strong and stable.
- 180cm height makes it possible for most to fully stand inside.
- The front and back panels can be fully rolled back, and feature side mosquito meshes and multi-configuration doors that can be used in closed, mosquito, or clear PVC window.

- Double door entry – door at each end of the bivvy for easy access.
- Mesh roof design for maximum ventilation.
- Heavy duty groundsheet, heavy duty moulded 'T' pegs, and oversized carry bag included.
- Supplied with a half Winter Skin as standard, a full Winter Skin is also available separately for added comfort in the most extreme conditions.

CODE	DIMENSIONS W/H/D (CM)	WEIGHT (KG)	BARCODE	TRADE PACK
MINI DOLMEN				
ACS540039	260 x 180 x 300	19.0		1
ACS540040 (Winterskin)	—	7.65		1

OUTHOUSE



Outhouse



Outhouse XL



- The Outhouse is a perfect shelter for cooking, storing extra equipment, or even as a back-up bivvy.
- The tall design allows you to stand up inside unhindered.
- Both the front and back can be fully opened for dual entry and to create excellent ventilation, particularly useful when cooking.
- PU Fabric 210D - Hydrostatic head: 5,000mm².
- Storm poles included.
- PE groundsheet, heavy duty moulded T pegs, and oversized carry bag included.
- Available in 2 sizes.



CODE	DIMENSIONS W/H/D (CM)	WEIGHT (KG)	BARCODE	TRADE PACK
OUTHOUSE				
ACS540035	220 x 210 x 150	14.6		1
OUTHOUSE XL				
ACS540036	220 x 220 x 250	18.5		1

BLAX

RAZORBACK BROLLY



**INCREDIBLE
VALUE
AND PRICE**

**NEW AUTUMN
2022**



Zip-in Front

- Flat back design – allows bedchair to be placed towards the back creating more useable floor space.
- Detachable centre pole for increased headroom.
- 8,000mm Hydrostatic Head / 200D Nylon PU fabric.
- Thermally taped seams throughout.
- Velcro rod straps.
- Storm poles included.

- Medium weight PVC groundsheet included.
- Heavy duty Moulded T pegs included.
- Oversize carry bag with double zips.
- Zip off front infill panel sold separately – solid centre door with mosquito mesh. Can be fished 'letter box' style.
- Infill panel sides can be rolled and clipped back.

CODE	DIMENSIONS W/H/D (CM)	WEIGHT (KG)	BARCODE	TRADE PACK
BLAX RAZORBACK BROLLY				
ACS540059	270 x 180 x 200	4.5		1
ACS540060 (Zip-in Front)	—	—		1

SCS+ (SUPER COMPACT SHELTER +)



**SUPER
COMPACT
AND PORTABLE**



- Perfect for anglers on the move or quick overnight sessions, the small footprint is ideal for tight swims or wooden platforms.
- Lightweight, compact & highly portable, the SCS+ features a space saving design that fits snugly around our latest ranged of 6 & 8 Leg bed chairs.

- ARMA-SKIN™ fabric - Hydrostatic Head 10,000mm².
- Lightweight pop-up fibreglass frame.
- Heavy duty groundsheet, heavy duty moulded 'T' pegs, and oversized carry bag included.

CODE	DIMENSIONS W/H/D (CM)	WEIGHT (KG)	BARCODE	TRADE PACK
SCS+				
ACS540054	220 x 120 x 120	6.2		1

SPEED-R



**QUICK
& EASY
ERECT**



Winterskin

- Based on a brolly frame design, the Speed-R is super quick to erect making it ideal for short to medium sessions or for anglers wanting to stay mobile.
- The special internal rib design offers excellent headroom when sat down inside.
- ARMA-SKIN™ fabric – Hydrostatic Head 10,000mm².
- Zip in front – solid, clear, mozzi mesh.

- 2x large rear vents.
- 4x storm poles included.
- Heavy duty groundsheet, heavy duty moulded 'T' pegs, and oversized carry bag included.
- A full Winter Skin is also available separately for added comfort in the most extreme conditions.

CODE	DIMENSIONS W/H/D (CM)	WEIGHT (KG)	BARCODE	TRADE PACK
SPEED-R				
ACS540043	290 x 150 x 230	15.5		1
ACS540044 (Winterskin)	—	5.0		1

BIVVY TABLE

- Foldable, telescopic legs with “oversized feet” for better stability.
- Light Aluminium structure.
- Transport handle.



CORD 15M

- Multi-use cord (15m long / 10mm diameter).
- Rot-proof polypropylene.
- Ideal for holding down bulky items.



12 PEGS & MALLET

- 12 robust screw-in pegs.
- Rubber mallet with soft grip handle.
- Cordura transport bag.



FOLDING SHOVEL

- A strong and versatile foldable shovel, supplied with a transport bag.
- Size of the shovel head: 21x15cm.
- Total length: 58cm.
- Folded length: 24cm.



PORTABLE SHOWER

- 20l portable shower.
- Leave shower in the sun to help increase the temperature of the water.
- Warning: it is advised to rinse out the shower between each use.



BLAX STORM POLES

- Strong and lightweight – 16 / 19mm Aluminium construction.
- Matt black finish.
- Toughened screw point ends.
- Capped inner tubes to prevent dirt ingress.
- T-bar included for extra turning power.
- Quick and easy Camlock adjustment.

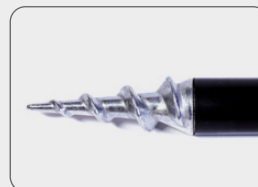

CODE	WIDTH (CM)	DEPTH (CM)	HEIGHT (CM)	CAPACITY (L)	WEIGHT (KG)	BARCODE	TRADE PACK
BIVVY TABLE							
ACS070011	65	45	40-60	—	2.95		1
12 PEGS AND MALLET							
ACS540019	35	9	—	—	1.68		1
CORD 15M							
ACS010117	—	—	—	—	0.45		1
PORTABLE SHOWER							
126300360	—	—	—	20	—		1
FOLDING SHOVEL							
ACS070019	—	—	—	—	1.10		1
BLAX STORM POLES							
ACS370101	—	—	40-60	—	—		1
ACS370099	—	—	55-90	—	—		1
ACS370100	—	—	75-130	—	—		1
ACS370102	—	—	100-180	—	—		1

ALARMS & INDICATORS

BITE ALARMS

ALARMS

- | BLAX 44
- | BLAX VX-R 45
- | HD2 46
- | HD3 47
- | HD4 48
- | HD5 49

SNAG EARS

- | SNAG EARS 50

INDICATORS

INDICATORS

- | X7 LED SWING ARM INDICATOR 50
- | ADJUSTABLE CHAIN HANGERS 50



ALARMS & INDICATORS

BLAX
ALARM



44

BLAX VX-R



45

BLAX VX-R
RECEIVER



45

HD2



46

Product Code	ACS490077	x3 SET – ACS490080	—	ACS490075
Key USP	AMAZING TRADE PRICE	BEST SELLER		NEW AND IMPROVED XSE MODEL
ON/OFF switch	●	●	●	●
Volume control	●	●	●	●
Tone control	●	●	●	●
Sensitivity control	●	●	—	●
Vibration	—	—	—	—
Mute feature	●	●	●	●
Drop back differentiate	—	—	—	●
Colour	●●●●	●	●	●●●●
Range	—	up to 150m	up to 150m	—
2.5mm jack output	●	●	—	—
Detachable Snag Ears	—	—	—	●
Number of LEDs	1	1	4	2
Multi-coloured LEDs	●	—	—	●
LED latching time (seconds)	20	20	20	15
Manual night mode	●	●	—	●
Low battery alarm	●	●	●	●
Battery type (not supplied)	x1 9v	x1 9v	x3 AAA 1.5v	x1 9v
All weather construction	●	●	●	●
Stainless steel screw thread	●	●	—	●
Clip on protection case	—	—	—	—
Accessory	—	—	Lanyard	—



HD3	HD3R	HD4	HD4R	HD5	HD5R
					
47	47	48	48	49	49
x3 SET – ACS490062	—	x3 SET – ACS490071	—	x3 SET – ACS490014	—
BEST SELLING COMPACT ALARM		NEW AND IMPROVED XTE MODEL		QUALITY, FEATURE PACKED ALARMS	
●	●	●	●	●	●
—	●	●	●	●	●
—	●	●	●	●	●
●	—	●	—	●	—
—	●	—	●	—	●
●	●	●	●	●	●
●	●	●	—	●	—
●●●●●●●●	●●●●●●●●	●●●●●●	●●●●●●	●●●●●●●●	●●●●●●●●
up to 150m	up to 150m	up to 150m	up to 150m	up to 150m	up to 150m
●	—	●	—	●	—
—	—	●	—	—	—
2	4	2	4	2	4
●	●	●	●	●	●
20	20	15	15	20	20
●	—	●	—	●	—
●	●	●	●	●	●
x1 V23GA 12V	x1 PP3 9V	x1 9v	x3 AAA 1.5v	x1 9v	x1 9v
●	●	●	●	●	●
●	—	●	—	●	—
●	—	●	—	●	—
—	Lanyard / Table Stand	—	Lanyard / Table Stand	—	Belt Clip / Table Stand



BLAX™ ALARM

- The BLAX entry level alarm is feature packed and outstanding value. Its compact design incorporates several features that are normally associated with more expensive bite alarms.
- Features include 4 volume settings, 4 tone settings, 4 levels of sensitivity, 20 second latching LED, nightlight mode, low battery warning, 2.5mm power out socket, stainless steel screw thread, high impact ABS moulded construction.
- Available as a set of 3 (red, yellow, green) or as a single alarm (blue).

BLAX Alarm Set (x3)



THE DETAIL

- 1 On/off and 4 volume settings (plus silent mode).
- 2 4 tone settings.
- 3 4 levels of sensitivity.
- 4 20 second latching LED / Night light mode.
- 5 2.5mm power out socket.
- 6 Stainless steel screw thread.
- 7 Soft rubber non-slip insert.



9v battery required (not supplied).

CODE	QUANTITY	COLOUR	BARCODE	TRADE PACK
BLAX ALARM				
ACS490076	3	Red, Yellow, Green		1
ACS490077	1	Blue		5

ALARM & RECEIVER

- The wireless model in the BLAX alarm range. Built using the same high impact construction mould as the entry level version, the VX-R model includes all the standard features, with the added benefit of a wireless function and receiver.
- Features include Hi-Viz blue LED's, 4 volume settings, 4 tone settings, 4 levels of sensitivity, 20 second latching LED, nightlight mode, low battery warning, 2.5mm power out socket, 150m range, stainless steel screw thread, high impact ABS moulded construction.
- Available as a set of 4 or 3 (protection case included).

BLAX V-XR Alarm Set (4+1)



BLAX V-XR Alarm Set (3+1)



THE DETAIL

- ① On/off and 4 volume settings (plus silent mode).
- ② 4 tone settings.
- ③ 4 levels of sensitivity.
- ④ 20 second latching LED / Night light mode.
- ⑤ 2.5mm power out socket.
- ⑥ Stainless steel screw thread.
- ⑦ Soft rubber non-slip insert.



THE DETAIL

- ① On/off and 4 volume settings (plus silent mode).
- ② 4 tone settings.
- ③ Hi-Viz blue LED's.

Lanyard supplied for receiver.



9v battery for alarm (not supplied) / 3x AAA, 1.5v batteries for receiver (not supplied).

CODE	QUANTITY	COLOUR	BARCODE	TRADE PACK
BLAX VX-R ALARM				
ACS490079	4+1	Blue		1
ACS490080	3+1	Blue		1

ALARM

HD2

- As the introductory alarm within the HD range, the HD2 model is perfect for anglers looking for a multi-function option that will perform in all conditions. Based on the previous XSE model chassis, the upgraded circuit boards and functionality result in a high-performance great value alarm.
- Adjustable 4 colour LED (Red, Yellow, Green, Blue), 15 second latching time, 30 second 'mute' feature, detachable black snag ears, 4 level volume, tone and sensitivity settings, drop back differentiation, nightlight mode, low battery warning, and high impact ABS moulded construction.

x12
COUNTER TOP
DISPLAY



THE DETAIL

- 1 Detachable snag ears.
- 2 Ultra-bright long life LED.
- 3 Nightlight.
- 4 Waterproof speaker.
- 5 Stainless steel screw thread.
- 6 Power out socket.
- 7 Soft rubber non-slip insert.
- 8 On / off power / nightlight button.
- 9 Volume control.
- 10 Tone control.
- 11 Sensitivity control.

Alarm uses 9V battery (not supplied).

CODE	ALARM QUANTITY	BARCODE	TRADE PACK
HD2 ALARM COUNTER TOP DISPLAY			
ACS490074	x12		1



ALARM

HD3



- Our smallest most compact design bite alarm we've ever produced. This has been achieved by removing the traditional front speaker from the alarm, leaving the job of audible indication to the speaker on the wireless HD3R receiver.
- Adjustable 6 colour LED (Red, Green, Blue, Yellow, Purple & White), 20 second latching, 150m range, low battery warning, nightlight mode, power out socket for illuminated bobbins, superb reliability, long battery life and a quality ABS body.
- A digital rolling code system also allows extra alarms to be purchased separately and programmed to an existing receiver.
- Available as set of 4, 3, 2 (protection case included) or single.

HD3 x4 HD3R x1



HD3 x3 HD3R x1



HD3 x2 HD3R x1



THE DETAIL

- 1 Ultra-bright long life LED.
- 2 LED colour control.
- 3 On/off power button.
- 4 Stainless steel screw thread.
- 5 Soft rubber non-slip insert.
- 6 Sensitivity control.
- 7 Power out socket.



HD3 Protective covers included.



THE DETAIL

- 1 On/off power / vibration switch.
- 2 LED Colour button.
- 3 LED Selection button.
- 4 Volume control.
- 5 Tone control.



HD3R table support and lanyard included.

Screw driver included.
Alarm uses 1x V23GA 12V Battery (not supplied). Receiver uses 1x 9V PP3 Battery (not supplied).

CODE	ALARM QUANTITY	RECEIVER QUANTITY	BARCODE	TRADE PACK
HD3 ALARMS AND HD3R RECEIVER				
ACS490061	4	1		1
ACS490062	3	1		1
ACS490063	2	1		1
HD3 ALARM				
ACS490064	1	—		1

ALARM

HD4

- The latest addition to the HD alarm range, the HD4 model offers a high quality, multi-function alarm option. Based on the previous XTE model chassis, the upgraded circuit boards, and functionality result in a high-performance great value alarm that won't let you down.
- Adjustable 4 colour LED (Red, Yellow, Green, Blue), 15 second latching time, 30 second 'mute' feature, detachable black snag ears, 4 level volume, tone, and sensitivity settings, drop back differentiation, nightlight mode, up to 150m range, 2.5mm power out socket, low battery warning, and high impact ABS moulded construction.



THE DETAIL

- 1 Detachable snag ears.
- 2 Ultra-bright long life LED.
- 3 Nightlight.
- 4 Stainless steel screw thread.
- 5 Power out socket.
- 6 Soft rubber non-slip insert.
- 7 On / off power / nightlight button.
- 8 Volume control.
- 9 Tone control.
- 10 Sensitivity control.



HD4 protective covers included.



THE DETAIL

- 1 On / off power button.
- 2 Volume control / vibration function.
- 3 Tone control.



HD4R table support and lanyard included with sets.

HD4 x4 HD4R x1



HD4 x3 HD4R x1



HD4 x2 HD4R x1



Alarm uses 9V battery (not supplied). Receiver uses 3x AAA 1.5V batteries (not supplied).

CODE	ALARM QUANTITY	RECEIVER QUANTITY	BARCODE	TRADE PACK
HD4 ALARMS AND HD4R RECEIVER				
ACS490070	4	1		1
ACS490071	3	1		1
ACS490072	2	1		1
HD4 ALARM				
ACS490073	1	—		1

ALARM

HD5

- Since its launch, the HD5 has become a firm favourite with carp anglers. Incorporating some of the latest technology available in electronic bite indication, the HD5 really does tick all the boxes. Reliability, long battery life and a quality build, nothing has been overlooked.
- Feature packed with dial adjustable sensitivity, 6 colour LED (Red, Green, Blue, Yellow, Purple & White), 20 second latching, 20 second afterglow period on alarm and receiver, 150m range, remote range self-testing, connection ring on receiver to secure it, low battery warning, nightlight mode, power out socket for illuminated bobbins, and a quality ABS body.
- A digital rolling code system also allows extra alarms to be purchased separately and programmed to an existing receiver.

HD5 x4 HD5R x1



HD5 x3 HD5R x1



HD5 x2 HD5R x1



THE DETAIL

- 1 Ultra-bright long life LED.
- 2 Tone control.
- 3 LED colour control.
- 4 Power out socket.
- 5 Stainless steel screw thread.
- 6 Soft rubber non-slip insert.
- 7 Volume control.
- 8 Sensitivity control.
- 9 On/off power / vibration switch.



HD5 Protective covers included.

THE DETAIL

- 1 Tone control.
- 2 On/off power / vibration switch.
- 3 LED Colour button.
- 4 LED Selection button.
- 5 Volume control.



HD5R with table support and belt clip included.



Both the bite alarm and the receiver operate on a 9V battery (not supplied).

CODE	ALARM QUANTITY	RECEIVER QUANTITY	BARCODE	TRADE PACK
HD5 ALARMS AND HD5R RECEIVER				
ACS490013	4	1		1
ACS490014	3	1		1
ACS490015	2	1		1
HD5 ALARM				
ACS490016	1	—		1

SNAG EARS

- Prevents lost rods when fishing locked up.
- Made from lightweight Aluminium.
- Simple to install underneath the bite alarm so that the upright ears sit directly behind the alarm.
- Universal fittings to accommodate most makes and models of alarm.

**X7 LED SWING ARM INDICATOR**

- Ability to change colour at the touch of a single button.
- Choose from 7 different colours: Red, Yellow, Green, White, Cool Blue, Purple and Blue.
- ABS moulded head.
- Quick release twist 'n' turn to attach to buzzer bars.
- Adjustable tension double ball line clip with grub screw.
- Adjustable sliding weight.
- Universal 2.5mm jack plug.
- CR2032 Battery (included).

**ADJUSTABLE CHAIN HANGERS**

- Supple chain for maximum sensitivity and a tension adjustable metallic line clip.
- Available as a set (which includes a protection case) or as individual bobbins.
- 4 different LED colours: Blue, Red, Green and Yellow.



CODE	COLOURS	QUANTITY	BARCODE	TRADE PACK
SNAG EARS				
ACS370000	—	—		1
X7 LED SWING ARM INDICATOR				
ACS490052		Set of 4		1
ACS490053		1		1
ADJUSTABLE CHAIN HANGERS				
138700360	Blue	1		1
138400360	Red	1		1
138600360	Green	1		1
138500360	Yellow	1		1
138900360	Blue, Red, Green, Yellow	Set of 4		1

BANKWARE & PODS

BANKWARE

BLAX

- | BANKSTICKS 53
- | BORA POINT BANKSTICKS 53
- | ADJUSTABLE & FIXED BUZZ BARS 54
- | DECK STAND 54
- | SINGLE BANKSTICK STABILISER 54
- | CROSS BAR SOLID STICK 54
- | ANGLE ADAPTOR 55
- | PILL ADAPTOR 55

INOX

- | BANKSTICKS 57
- | QR BORA POINT BANKSTICKS 57
- | ADJUSTABLE & FIXED BUZZ BARS 58
- | CROSS BAR SOLID STICKS 59
- | T-TOP BANKSTICK DRIVER 59
- | BANKSTICK STABILISERS 59
- | DECK STAND 59
- | QR PILL PACK 60
- | 2 IN 1 KEY TOOL 60
- | ANGLE ADAPTOR 60
- | SNAG EARS 60
- | WEIGH HOOK 60

ROD RESTS

- | 2/4 ROD SET SUPPORT 60
- | STAINLESS STEEL ADJUSTABLE HEAD 60
- | QUICK RELEASE ADAPTER 60
- | LOCKING BUTT GRIP 61
- | BUTT RESTS 61

PODS

- | BLAX™ ALU-LITE POD BASE 62
- | BLAX™ TWIN THREAD BUZZ BARS 62
- NEW | BLAX X-POD SYSTEM 63
- | BLAX™ ROD POD 63
- | INOX™ ROD POD 64





BLAX™

 Designed and developed in the UK



BLAX Aluminium bankware is lightweight, functional and really looks the part on the bank. Extensively tested by the Carp Spirit team, the 16mm Aircraft grade Aluminium tube is both sturdy and ultra-light weight.

Features include:

- Lightweight 6063 Aluminium.
- No Loss Tri-lobe Thumb screws.
- Durable Black Anodised Finish.
- Designed Using C.A.D. (Computer Aided Design).
- Compatible with the 2 in 1 key (sold separately).

Carp Spirit BLAX Bankware is a full range incorporating:

- Banksticks – Standard and Bora Point versions.
- Buzzer Bars – Fixed, Adjustable and XL versions.
- Bankstick Stabilisers.
- Deck stands.

QUALITY, INNOVATION AND DESIGN – THE CARP SPIRIT BLAX BANKWARE RANGE

BLAX BANKSTICKS

- Ultra-light 6063 Aluminium.
- Durable Black Anodised Finish.
- 16mm diameter.
- Pointed internals to double up as stalking sticks.
- No Loss Tri-lobe Thumb screws.
- Compatible with the 2 in 1 key (sold separately).



BLAX BORA POINT BANKSTICKS

- Ultra-light 6063 Aluminium.
- Durable Black Anodised Finish.
- Hardened 'BORA POINT' tip.
- 16mm diameter.
- Pointed internals to double up as stalking sticks.
- No Loss Tri-lobe Thumb screws.
- Compatible with the 2 in 1 key (sold separately).



CODE	LENGTH (IN)	LENGTH (CM)	WEIGHT (G)	BARCODE	TRADE PACK
BLAX BANKSTICKS					
ACS370056	9	23/30.5	84		1
ACS370057	12	30/46	104		1
ACS370058	16	40/68	128		1
ACS370059	20	55/85	156		1
ACS370060	28	70/125	205		1
BLAX BORA POINT BANKSTICKS					
ACS370061	9	23/30.5	84		1
ACS370062	12	30/46	104		1
ACS370063	16	40/68	128		1
ACS370064	20	55/85	156		1
ACS370065	28	70/125	205		1

BLAX™

BLAX FIXED BUZZ BARS

- Durable Black Anodised Finish.
- 16mm diameter.
- Ultra-light 6063 Aluminium.
- XL and Standard lengths available.

BLAX ADJUSTABLE BUZZ BARS

- Durable Black Anodised Finish.
- Anti-twist flat milled inserts.
- 16mm diameter.
- Ultra-light 6063 Aluminium.
- No Loss Tri-lobe Thumb screws.
- Compatible with the 2 in 1 key (sold separately).

2 ROD FIXED BUZZ BARS

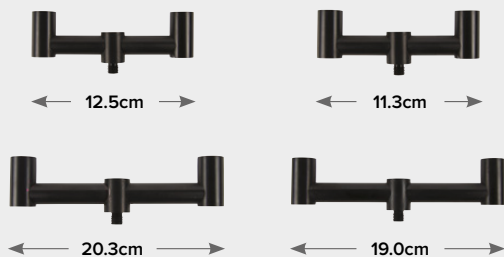

3 ROD FIXED BUZZ BARS

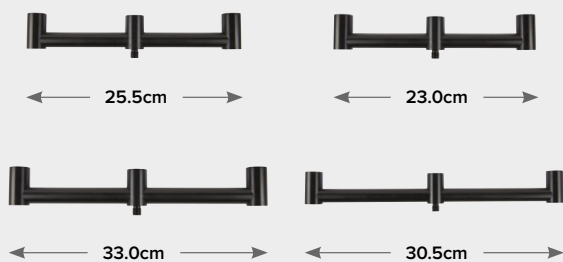

2/3 ROD ADJUSTABLE BUZZ BARS

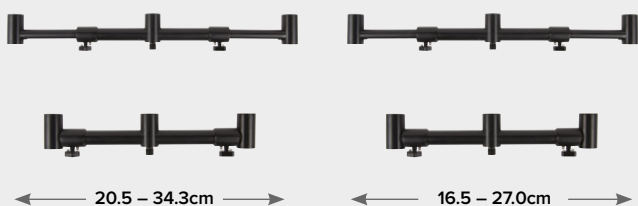

BLAX DECK STAND

- Can be screwed directly into wooden platforms to provide rock solid support for upright banksticks eliminating the need for a pod.



BLAX CROSS BAR SOLID STICK

- Can be used as a brace between the front and rear upright bank sticks to prevent twist and increase rigidity.
- Alternatively use a pair in an 'X' shape to convert a 'goal post' set up into a free-standing solid rod pod.



BLAX BANK STICK STABILISER

- Designed to eliminate banksticks from twisting in soft ground.



BLAX ANGLE ADAPTOR

- Perfect for fishing steep and sloping banks to ensure that the bite alarm and rod rests are at 90 degree to the rod.
- Simply set the desired angle and lock in place at the turn of a screw.

**BLAX PILL ADAPTOR**

- An ideal upgrade for anglers who already own Carp Spirit BLAX bank ware range.
- The BLAX pill adaptor simply screws into the top of any bankstick or buzz bar to convert it into a quick release system.



CODE	SIZE	LENGTH (CM)	WEIGHT (G)	BARCODE	TRADE PACK
2 ROD FIXED BUZZ BARS					
ACS370066 (Front)	Standard	12.5	78		1
ACS370079 (Rear)	Standard	11.3	75		1
ACS370067 (Front)	XL	20.3	89		1
ACS370080 (Rear)	XL	19.0	86		1
3 ROD FIXED BUZZ BARS					
ACS370068 (Front)	Standard	25.5	99		1
ACS370081 (Rear)	Standard	23.0	96		1
ACS370069 (Front)	XL	33.0	116		1
ACS370082 (Rear)	XL	30.5	112		1
2/3 ROD ADJUSTABLE BUZZ BARS					
ACS370070 (Front)	—	20.5 – 34.3	183		1
ACS370083 (Rear)	—	16.5 – 27.0	164		1
DECK STAND					
ACS370072	—	—	53		1
CROSS BAR SOLID STICK					
ACS370084	—	—	—		1
SINGLE BANKSTICK STABILISER					
ACS370073	—	—	53		1
ANGLE ADAPTOR					
ACS370086	—	—	—		1
PILL ADAPTOR					
ACS370087	—	—	—		1

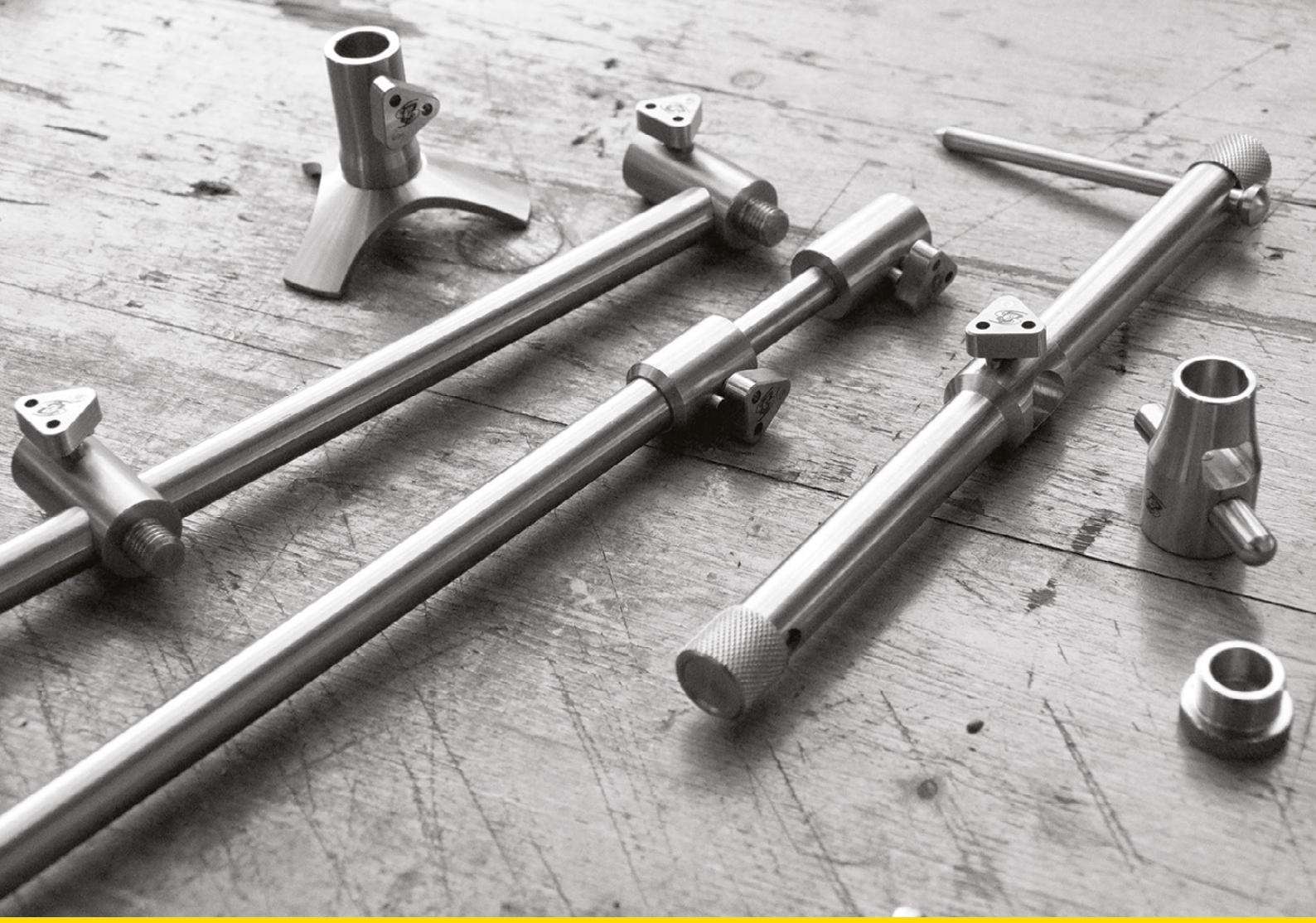

INOX 300

STAINLESS STEEL

 DESIGNED AND DEVELOPED IN THE UK

- The Carp Spirit INOX 300 stainless steel range is the result of over 2 year's extensive design, development and testing.
- Designed completely from the ground up using CAD (Computer Aided Design) the extensive range covers a multitude of rod support set ups and is machined entirely from ultra-high grade 300 Series Stainless Steel.
- Made to last and provide years of trouble free service, innovative designs and features such as the quick release (QR) 'Pill' system have been introduced, along with some totally unique products such as the 2 in 1 deck stand and 'safe storage' bankstick stabilisers.
- Quality, Innovation and Design – The Carp Spirit INOX 300 Series.





BANKSTICKS

- Machined from ultrahigh grade 300 Series Stainless Steel and will provide years of trouble free use.
- No Loss Tri-lobe thumb screw design.
- Hollow tube inserts for reduced weight.
- Pointed inserts double up as stalking sticks.
- 3/8" BSF Thread.
- Compatible with the 2 in 1 key (sold separately).

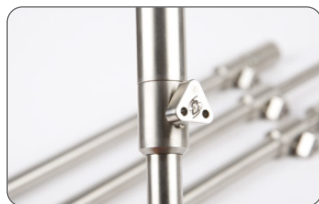

BORA POINT BANKSTICKS

- Machined from ultrahigh grade 300 Series Stainless Steel and will provide years of trouble free use.
- Feature a quick release 'Pill' system which allows alarms to be quickly removed or butt rests to be changed in seconds.
- The 'Bora Point' design is perfect for drilling the banksticks into hard ground.
- No Loss Tri-lobe thumb screw design.
- Hollow tube inserts for reduced weight.
- Pointed inserts double up as stalking sticks.
- 3/8" BSF Thread.
- Compatible with the 2 in 1 key (sold separately).



CODE	LENGTH (IN)	LENGTH (CM)	WEIGHT (KG)	BARCODE	TRADE PACK
BANKSTICKS					
ACS370026	9	23/33	200		1
ACS370027	12	30/46	235		1
ACS370028	16	40/66	305		1
ACS370029	20	51/86	365		1
QR BORA POINT BANKSTICKS					
ACS370030	9	23/33	210		1
ACS370031	12	30/46	250		1
ACS370032	16	40/66	305		1
ACS370033	20	51/86	360		1



BUZZ BARS

- Machined from ultrahigh grade 300 Series Stainless Steel and will provide years of trouble free use.
- Feature a quick release 'Pill' system which allows alarms to be quickly removed or butt rests to be changed in seconds.
- The 2 & 3 rod versions feature three male 3/8" BSF threads allowing them to be used with either single banksticks or in a 'goal post' style set up with bank sticks at either end.
- No Loss Tri-lobe thumb screw design.
- Hollow tube inserts for reduced weight.
- 3/8" BSF Thread.
- Compatible with the 2 in 1 key (sold separately).



2/3 RODS ADJUSTABLE BUZZ BAR

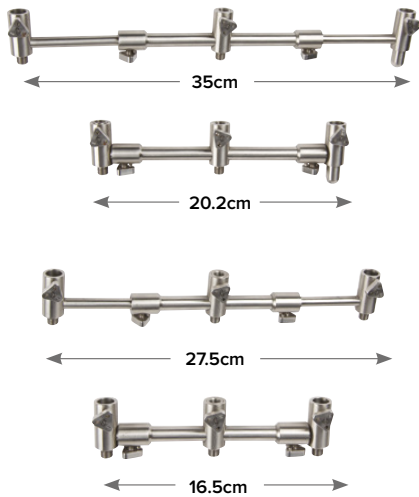

2 RODS FIXED BUZZ BAR

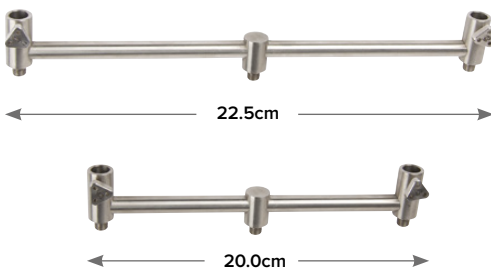

3 RODS FIXED BUZZ BAR

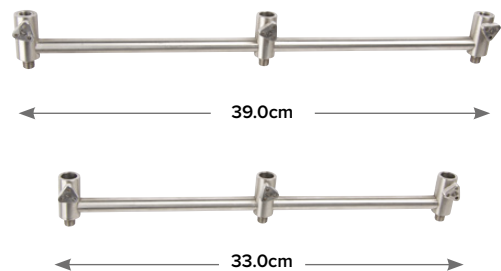



BANKSTICK STABILISER

- Designed to eliminate banksticks from twisting in soft ground.



T-TOP BANKSTICK DRIVER

- Driver features a solid stainless steel cross bar making it the ideal tool for driving banksticks into hard ground, instead of risking bending buzz bars.



2 IN 1 DECK STAND & ANTI TWIST COLLAR

- A 2 in 1 product that can be used to either screw into wooden platforms for rock solid support or applied to soft ground for increased stability.



CODE	RODS	LENGTH (CM)	WEIGHT (G)	BARCODE	TRADE PACK
2/3 RODS ADJUSTABLE BUZZ BAR					
ACS370034 (Front)	2/3	20.2 – 35.0	375		1
ACS370051 (Rear)	2/3	16.5 – 27.5	355		1
2 RODS FIXED BUZZ BAR					
ACS370035 (Front)	2	22.5	245		1
ACS370052 (Rear)	2	20.0	235		1
3 RODS FIXED BUZZ BAR					
ACS370036 (Front)	3	39.0	310		1
ACS370053 (Rear)	3	33.0	295		1
T-TOP BANKSTICK DRIVER					
ACS370039	—	—	300		1
BANKSTICK STABILISER					
ACS370050 (Single)	—	—	125		1
ACS370041 (Double)	—	—	205		1
2 IN 1 DECK STAND & ANTI TWIST COLLAR					
ACS370040	—	—	110		1



QR PILL PACK

- The pill adaptor simply screws into the top of any bankstick or buzz bar to convert it into a quick release system.



(key not included).

2/4 ROD SUPPORT SET

- 2 / 4 rod support set ideal for short sessions.
- 2 rod – Use as front and back support.
- 4 rod – Use as front support only.
- Transport bag include.



2 IN 1 KEY TOOL

- Perfect for tightening and or unscrewing our anti-loss screws.



WEIGH HOOK

- Design allows the hook to rotate 360° for quick and easy location onto weigh sling straps.



ANGLE ADAPTOR

- Designed to be inserted in-between the bankstick and buzz bar to provide additional angle adjustment.



STAINLESS STEEL ADJUSTABLE HEAD

- Easily adjustable support thanks to the two systems of lateral and lower screws.
- It will perfectly support your rod, either in 10, 12 or 13 feet, thanks to a precise adjustment of the spacing of the supporting lamellae.
- The lamellae are even topped with a “soft touch” grip in order to avoid any slipping of the rod and to protect the butt section.
- The whole support is made with corrosion resistant materials for a longer durability.



SNAG EARS

- High quality stainless steel.
- Front connector for receiving hanger.



QUICK RELEASE ADAPTOR

- Instant pull back release.
- Strong and secure.
- Multitude of uses.



LOCKING BUTT GRIP

- Clamp down design – securely locks rods into place.
- Automatically releases when rod is lifted.
- Anti-slip moulded inserts.
- Will accept rods up to 22mm diameter.
- 3/8 BSF stainless steel thread.
- Black alignment collar and rubber washer included.



BUTT RESTS

- Strong, flexible moulded Nylon.
- Ideal for rod butts up to 22mm diameter (Slim), or 26mm diameter (Standard).
- 3/8 BSF thread.
- Black alignment collar and rubber washer included.
- Available in standard or slim sizes



CODE	QUANTITY (PER PACK)	COLOUR	WEIGHT (G)	BARCODE	TRADE PACK
QR PILL PACK					
ACS370043	2	—	—		1
2 IN 1 KEY TOOL					
ACS370042	1	—	—		1
ANGLE ADAPTOR					
ACS370085	1	—	—		1
SNAG EARS					
ACS370044	1	—	—		1
WEIGH HOOK					
ACS370055	1	—	70		1
2/4 ROD SUPPORT SET					
ACS370004	1	Black	0.95		1
STAINLESS STEEL ADJUSTABLE HEAD					
ACS370020	1	—	—		3
QUICK RELEASE ADAPTOR					
ACS370012	1	—	—		3
LOCKING BUTT GRIP					
ACS370107	1	Black	—		5
BUTT RESTS					
ACS370109 (Standard)	1	Black	—		5
ACS370108 (Slim)	1	Black	—		5



BLAX ALU-LITE POD BASE

- Strong, stable & lightweight 6063 Aluminium construction.
- Matt black finish.
- Quick and easy Camlock adjustment.
- Compact folding design.
- 4x adjustable legs.
- Height adjustable uprights.
- Adjustable length 60cm – 100cm.
- Legs can be removed and used as Banksticks.
- Supplied in carry bag.
- Weight 1.2kg.
- Accepts all BLAX Twin Thread Buzz Bars.*



*Can be combined perfectly with the BLAX Twin Thread Buzz Bars. Available separately, see below.

BLAX TWIN THREAD BUZZ BARS

- Lightweight 6063 Aluminium.
- Matt black finish.
- Twin thread design with moulded threads.
- Can be used with Banksticks for a goal post set up.
- Compatible with BLAX Alu-Lite Pod Base.
- Sold in pairs (front & rear).



2 rod



3 rod



4 rod

CODE	VERSION	DIMENSIONS (CM)	BARCODE	TRADE PACK
BLAX ALU-LITE POD BASE				
ACS370103	—	—		1
BLAX TWIN THREAD BUZZ BARS				
ACS370104	2 Rod	Front - 30.5cm / Rear - 28cm		1
ACS370105	3 Rod	Front - 44cm / Rear - 40.5cm		1
ACS370106	4 Rod	Front - 61cm / Rear - 56.5cm		1

BLAX™**NEW 2023**

X-POD SYSTEM

- Light Weight 6063 Aluminium.
- No Loss trilobe thumb screws.
- Durable Black Anodised finish.
- 2 in 1 key included.
- 4x Adjustable banksticks – 2 x 8" / 2 x 10".
- 2x Buzz bars (Front & Rear).
- Can be used for 2 / 3 rod set ups – 2x Blanking screws included.
- Buzz bar thread covers included.
- Buzz bars can be used with single bank sticks or double banksticks 'goal post' style.
- Accepts all BLAX banksticks – Can be used 'rods up' with longer banksticks.
- Folded length 50 cm.
- Extends 75cm to 115cm.
- Weight 450g (Pod only).
- Weight 1.1 Kg (complete).
- Supplied in a Zipped carry case.

**BLAX™**

ROD POD

- Manufactured from lightweight Aero Space grade 6063 Aluminium.
- Fully adjustable length and height; incredibly strong and stable.
- Additional pair of XL legs are included as standard so that rods can be fished pointing up in the air or for when fishing steep and slopping banks.
- Supplied with carry bag as standard.
- Durable Black Anodised finish.
- Available in 2/3 rod and 3/4 rod versions.



3/4 Rod Version



CODE	VERSION	WEIGHT (KG)	BARCODE	TRADE PACK
BLAX X-POD SYSTEM				
ACS370110	—	450g (Pod only) – 1.1kg (complete)		1
BLAX ROD POD				
ACS370090	2/3 rod	3.5		1
ACS370091	3/4 rod	4.0		1



INOX ROD POD

- Machined entirely from ultra-high grade 300 series stainless steel.
- Features unique 'dutch pin' spring lock system for rapid set and pack down.
- This innovative design allows the legs and uprights to be deployed and locked into place in just a matter of seconds.
- Designed to cope with all manner of surfaces and slopes, the legs can be locked into place at 90°, 45° or at a lower position of 22.5°.
- Each upright feature a quick release drop in adaptor to further aid quick set up and are compatible with all INOX buzz bars.
- Available as either a base only, or a 3 rod fixed option.



'Dutch Pin' spring lock system.



Pill system.

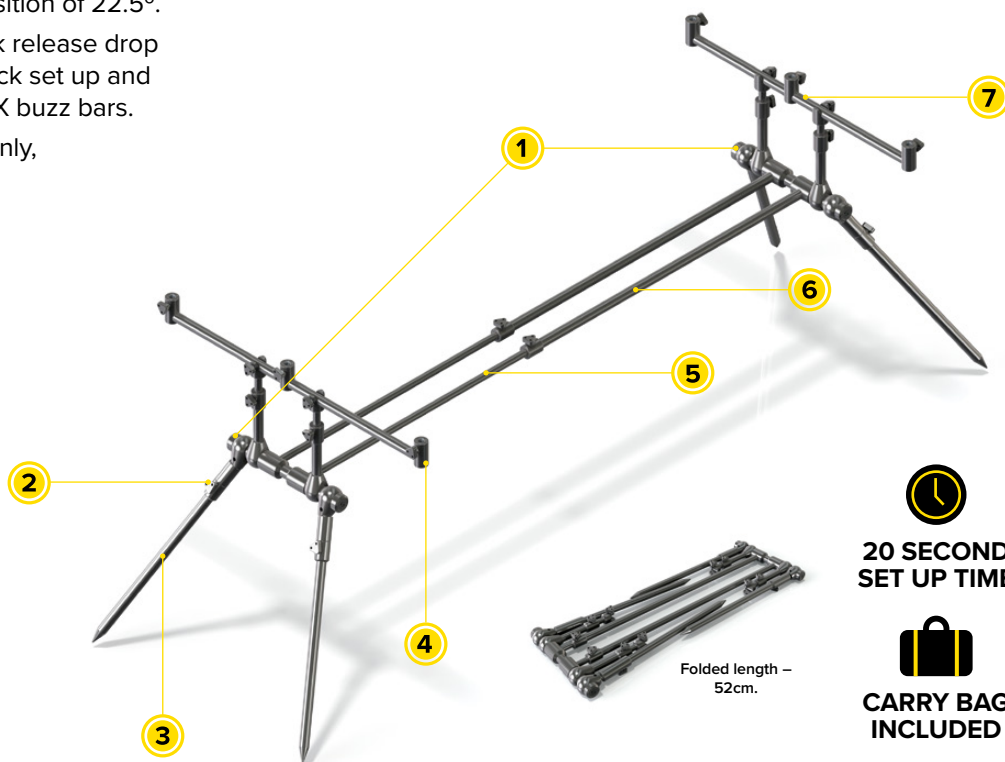

THE DETAIL

- 1 Unique spring lock bar system for rapid set up.
- 2 Legs can be set at 22.5, 45 or 90 degrees.
- 3 Long banksticks can be used for fishing 'rods up'.
- 4 No loss thumb screw design.
- 5 Machined from ultra-high grade 300 series stainless steel.
- 6 Hollow tube inserts for reduced weight.
- 7 Quick release drop in uprights designed to fit all INOX buzz bars.



**20 SECOND
SET UP TIME**

**CARRY BAG
INCLUDED**

CODE	VERSION	WEIGHT (KG)	BARCODE	TRADE PACK
INOX ROD POD				
ACS370094	Complete	4.13		1
ACS370093	Base Only	3.50		1

RODS

BLAX

- | 13' 3.50LB 68
- | 13' 3.00LB 68
- | 12' 3.50LB 68
- | 12' 3.00LB 68
- | 12' 2.75LB 68
- | 10' 3.00LB 68

BLAX SPOD

- | 12' 5.00LB 69
- | 12' 4.50LB 69

BLAX MARKER

- | 12' 3.75LB 69

MAGNUM X1

- | 13' 3.50LB 70
- | 13' 3.00LB 70
- | 12' 3.00LB 70
- | 12' 2.75LB 70
- | 10' 3.00LB 70

MAGNUM X3

- | 13' 3.50LB 71
- | 12' 3.50LB 71
- | 12' 3.00LB 71
- | 10' 3.00LB 71

MAGNUM X5

- | 13' 3.50LB 72
- | 12' 3.50LB 72
- | 12' 3.00LB 72
- | 10' 3.00LB 72

MAGNUM XLR

- | 13' 3.75LB 73

MAGNUM SPOD & MARKER

- | 12' 6" 5.00LB 74



ROD SPECIFICATION

Product	Modulus	NMC Carbon	ASF Finish	Anti-Frap Tip Guide
BLAX Series 68	30-Ton	—	—	—
BLAX Spod 69	30-Ton	—	—	—
BLAX Marker 69	30-Ton	—	—	—
MAGNUM X1 70	36+30-Ton	—	—	●
MAGNUM X3 71	36-Ton	●	●	●
MAGNUM X5 72	40-Ton	●	●	●
MAGNUM XLR 73	46-Ton	●	●	●
MAGNUM Spod and Marker 74	36+30-Ton	—	—	●

NANO MATRIX CARBON



Our multi walled Nano-Matrix Carbon blanks are so strong because they are made up of a single chain of unbroken covalent carbon to carbon bonds within the low resin pre-preg; the end result is slimmer, lighter and higher performance rod blanks.

This process is reserved exclusively for our top of the range Magnum rods XLR, X5 and X3 series.

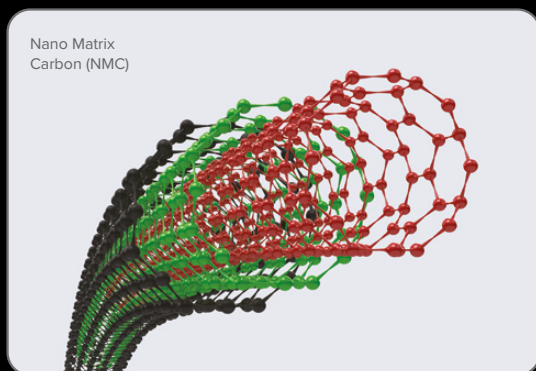

ANTI-SCRATCH FINISH



All blanks that feature ASF are precision laser ground to ultra-high tolerances.

This removes the traditional requirement to apply paint or varnish to the blank, and is therefore the final process before any components are fitted.

The end result is a smooth, long lasting and durable surface finish, which will ensure that your rods will still look as good as the day that you bought them, even after many years of use.

STAINLESS STEEL BUTT CAP



Manufactured from 300 series grade stainless steel with a laser etched Logo. The hard nature of stainless steel is more durable and resistant to damage.

ANTI-FRAP TIP GUIDES



Anti-Frap tip guides feature smooth and blended side bracings between the tube and centre frame. This special shape greatly reduces the chances of line getting wrapped around the tip of the blank before, during or after the cast.

FUJI BKWAG GUIDES



Highest quality, tangle free, Japanese rod guides with lightweight Alconite centres. The special smooth shape of the frame makes them perfect for extreme distance casting and when heavy duty shock leaders are required.

Guide Model	Guide Type	Butt Cap	Colour Guide	Reel Seat	Handle
Sea-Guide BTLTSG	Double Leg	Aluminium	Black	18mm DPS	Abbreviated
Sea-Guide BTLTSG	Double Leg	Aluminium	Black	18mm DPS	Abbreviated
Sea-Guide BTLTSG	Double Leg	Aluminium	Black	18mm DPS	Abbreviated
Sea-Guide BTLTSG + XUT	Double Leg	Aluminium	Black	18mm DPS	Full Japanese Shrink
Sea-Guide TUXTLSG + XUT	Double Leg	SS	Gunsmoke	18mm DPS	Abbreviated
Sea-Guide TUXTLSG + XUT	Double Leg	SS	Gunsmoke	18mm DPS Fuji	Abbreviated
Fiji Alconite BKWAG	Double Leg	SS	Black	ALPS	Abbreviated
Sea Guide BTLSG + XUT	Double Leg	SS	Black	18mm DPS	Full Japanese Shrink

SEA-GUIDE GUIDES



TUXTLSG – Highest quality, lightweight, double leg guides with a Titanium finished frame. Featuring Silicon Carbide centres and externally rolled frames to help prevent guide centre damage.

BTLTSG – High quality, lightweight, double leg guides with a black anodised finish. Featuring Silicon Carbide centres and externally rolled frames to help prevent guide centre damage.

BTLSG – High quality, lightweight, double leg guides with a black anodised finish. Featuring Silicon Carbide centres and externally rolled frames to help prevent guide centre damage.

CARBON CLONE REEL SEAT



Machined entirely from a carbon tube and featuring a 1K weave, this reel seat is ultra light weight and perfectly matches the rod weave and cosmetics. It will accept both big pit and standard size reels.

FUJI DPS REEL SEAT



High quality Japanese moulded reel seat that is both secure and comfortable. Will accept both big pit and standard size reels.

ALPS REEL SEAT



Highest quality, light weight and incredibly strong. The ALPS reel seat is machined entirely from aerospace grade Aluminium and anodised in black.

The dual collars and nylon lock washer provide an incredibly strong and secure fixing for even the largest of big pit reels. Perfect for withstanding the torque and turning forces generated during extreme distance casting.

1-K WEAVE



The tightest weave we use on our rods. The multi-directional carbon fibres are interwoven at a rate of 1mm x 1mm, providing thousands of overlays across the blank length.

The end result is added strength to the blank itself and increased tip speed recovery to aid both casting distance and accuracy.

3-K WEAVE



Multi-directional carbon fibres are interwoven at a rate of 3mm x 3mm, providing thousands of overlays across the blank length.





The end result is added strength to the blank itself, and increased tip speed recovery to aid both distance casting and accuracy.











BLAX™

BLAX CARP RODS

- A series of rods that have been designed and developed to be 'best in class'.
- At first glance you would be forgiven for thinking that the BLAX rods are twice their actual price and rightly so.
- Slim, lightweight, dark matte blanks have been constructed using the finest 30-Ton carbon pre-preg.
- Built using high quality SIC Sea-Guides and lightweight anodised Aluminium fittings.
- Amongst the standard test curves, you will find some fantastic utility rods such as the 10ft rod, ideal for stalking or for use in tight swims.

-  **SEA-GUIDE BTLTSG GUIDES**
High quality Black finish SIC double leg guides.
-  **18MM DPS REEL SEAT**
-  **MATT FINISH BLANK**
-  **ABBREVIATED HANDLE DESIGN**
-  **BLACK ANODISED FITTINGS**



CODE	LENGTH (FT/M)	TEST CURVE (LB)	GUIDE SIZES	REC. CAST WEIGHT	BARCODE	TRADE PACK
BLAX SERIES 2 SECTION RODS						
ACS170012	13/3.96	3.50	50-40-30-25-20 +16T	100-160g		1
ACS170013	13/3.96	3.00	50-40-30-25-20 +16T	80-120g		1
ACS170014	12/3.66	3.50	50-40-30-25-20 +16T	90-140g		1
ACS170015	12/3.66	3.00	50-40-30-25-20 +16T	80-120g		1
ACS170024	12/3.66	2.75	40-30-25-20-16 +16T	60-100g		1
ACS170016	10/3.05	3.00	40-30-25-20-16 +16T	60-100g		1
BLAX SERIES 3 SECTION RODS						
ACS170021	13/3.96	3.00	50-40-30-25-20 +16T	80-100g		1
ACS170022	12/3.66	3.00	40-30-25-20-16 +16T	80-100g		1



BLAX™

BLAX SPOD RODS

Spod rods are a key part of any carp angler's armoury and our BLAX spod rods are well up to the job, both versions feature powerful but progressive actions, with huge power reserves in the butt section.

- SEA-GUIDE BTLTG GUIDES – High quality Black finish SIC double leg guides.
- 18MM DPS REEL SEAT.
- MATT FINISH BLANK.
- ABBREVIATED HANDLE DESIGN.
- BLACK ANODISED FITTINGS.



2 or 3 section options available.

BLAX MARKER ROD

The BLAX marker rod features a powerful butt section to help cast out marker floats yet retains a degree of sensitivity towards the end of the tip section to help identify and read the features of the lakebed.

- 2x depth gauge at 30cm and 50cm.
- SEA-GUIDE BTLTG GUIDES – High quality black finish SIC double leg guides.
- 18MM DPS REEL SEAT.
- MATT FINISH BLANK.
- ABBREVIATED HANDLE DESIGN.
- BLACK ANODISED FITTINGS.
- LUMINOUS TIP END SECTION – perfect for low light and night-time conditions.



CODE	LENGTH (FT/M)	TEST CURVE (LB)	GUIDE SIZES	REC. CAST WEIGHT	BARCODE	TRADE PACK
BLAX SPOD ROD – 2 SECTION						
ACS170017	12/3.66	5.00	50-40-30-25-20 +16T	160-240g		1
BLAX SPOD ROD – 3 SECTION						
ACS170018	12/3.66	4.50	50-40-30-25-20 +16T	150-190g		1
BLAX SERIES MARKER ROD						
ACS170025	12/3.66	3.75	50-40-30-25-20 +16T	90-130g		1



MAGNUM[®] X1

MAGNUM X1

BEST SELLER

- A rod that has stunning looks, fantastic performance, and great value.
- Featuring the trademark Magnum series semi-fast action, the blank is made using a special blend of 36 and 30-Ton hi-modulus carbon and a small section of 3K weave above the reel seat.
- Cosmetics are both minimalistic and subtle featuring a full Japanese shrink wrapped handle.
- Matt finished blanks with a deep grey undertone and black Sea-Guide SIC guides make the Magnum X1 a serious contender for any angler's armoury.



ANTI-FRAP TIP GUIDE
Reduces line wrapping around the tip.



SEA-GUIDE BTLTSG GUIDES
High quality Black finish SIC double leg guides.



STAINLESS STEEL BUTT CAP
Featuring laser etched logo.



18MM DPS REEL SEAT



MATT FINISH BLANK



FULL JAPANESE SHRINK WRAP HANDLE DESIGN



CODE	LENGTH (FT/M)	TEST CURVE (LB)	GUIDE SIZES	REC. CAST WEIGHT	BARCODE	TRADE PACK
MAGNUM X1						
ACS170008	13/3.96	3.50	50-40-30-25-20 +16T	100-160g		1
ACS170009	13/3.96	3.00	50-40-30-25-20 +16T	80-120g		1
ACS170026	12/3.66	3.50	50-40-30-25-20 +16T	90-140g		1
ACS170010	12/3.66	3.00	50-40-30-25-20 +16T	80-120g		1
ACS170023	12/3.66	2.75	40-30-25-20-16 +16T	60-100g		1
ACS170011	10/3.05	3.00	40-30-25-20-16 +16T	60-100g		1



**OUR MOST
VERSATILE
ROD**





MAGNUM[®] X3

MAGNUM X3

- Manufactured from 36-Ton Hi-Modulus Nano Matrix Carbon (NMC) the Magnum X3 range is a series of rods with a semi fast action that offer fantastic performance.
- The butt section holds plenty of power in reserve for casting heavy leads and PVA bags, yet the tip section is still forgiving enough to absorb the lunges during a fight.
- The high-quality Fuji reel seat is compatible with both big pit and standard size reels, and the ASF technology blanks finished in a 3K weave ensure that the Magnum X3 Series will be a firm favourite.
- Available in a range of lengths and text curves.

-  **NANO MATRIX CARBON**
Stronger, lighter, Higher Performance Blanks.
-  **ANTI-SCRATCH FINISH**
Ensures your rods look great after years of use.
-  **ANTI-FRAP TIP GUIDE**
Reduces line wrapping around the tip.
-  **SEA-GUIDE TUXTLG GUIDES**
Highest quality Titanium finish SIC double leg guides.
-  **STAINLESS STEEL BUTT CAP**
Featuring laser etched logo.
-  **CARBON CLONE REEL SEAT – 18MM**
Ultra lightweight and machined from carbon tube.
-  **3-K WEAVE**
For added strength and increased tip speed recovery.









CODE	LENGTH (FT/M)	TEST CURVE (LB)	GUIDE SIZES	OPT. CAST WEIGHT	BARCODE	TRADE PACK
MAGNUM X3						
ACS170005	13/3.96	3.50	50-40-30-25-20 +16T	100-160g		1
ACS170006	12/3.66	3.50	50-40-30-25-20 +16T	90-140g		1
ACS170007	12/3.66	3.00	50-40-30-25-20 +16T	80-120g		1
ACS170027	10/3.05	3.00	40-30-25-20-16 +16T	60-100g		1







MAGNUM[®] X5

MAGNUM X5

- Our top of the range Magnum X5 rods are all manufactured from 40-Ton High Modulus Nano Matrix Carbon (NMC), which gives the blanks their ultra slim diameter yet still provides plenty of power in reserve.
- All the Magnum Series rods feature the same semi fast action, which, after extensive testing by the Pro team was found to be the perfect balance between being able to cast leads to extreme distances yet still retain a tip soft enough to absorb the lunges of the fish during key stages of the fight.
- Built using only the highest quality fittings including a carbon clone reel seat and an ASF technology blank, the Magnum X5 series are without doubt the ultimate carp fishing rods available today.

-  **NANO MATRIX CARBON – NMC**
Stronger, lighter, Higher Performance Blanks.
-  **ANTI-SCRATCH FINISH**
Ensures your rods look great after years of use.
-  **ANTI-FRAP TIP GUIDE**
Reduces line wrapping around the tip.
-  **SEA-GUIDE TUXTLG GUIDES**
Highest quality Titanium finish SIC double leg guides.
-  **STAINLESS STEEL BUTT CAP**
Featuring laser etched logo.
-  **CARBON CLONE REEL SEAT – 18MM**
Ultra lightweight and machined from carbon tube.
-  **1-K WEAVE**
For added strength and increased tip speed recovery.



CODE	LENGTH (FT/M)	TEST CURVE (LB)	GUIDE SIZES	OPT. CAST WEIGHT	BARCODE	TRADE PACK
MAGNUM X5						
ACS170002	13/3.96	3.50	50-40-30-25-20 +16T	100-160g		1
ACS170003	12/3.66	3.50	50-40-30-25-20 +16T	90-140g		1
ACS170004	12/3.66	3.00	50-40-30-25-20 +16T	80-120g		1
ACS170028	10/3.05	3.00	40-30-25-20-26 +16T	60-100g		1



MAGNUM[®] XLR

MAGNUM XLR

- A rod like no other! XLR means Xtra-Long Range, and that is exactly the sole purpose of this rod. To deliver baits and PVA bags to the horizon.
- Made from Hi-Modulus Nano Matrix 46-ton carbon and wrapped in a 1K weave along its full length.
- Key to achieving these kinds of distances is the specially tapered butt section. So fast is the taper that the XLR will easily cope with leads up to 6oz in weight.
- Of course, pushing rods like this to the limit demands the highest performance fittings. That's why we chose a CNC machined Alps reel seat for maximum reel security, and Fuji BKWAG to cope with the fast line speed and heavy duty shock leaders required for such a specialist tool.



NANO MATRIX CARBON
Stronger, lighter, Higher Performance Blanks.



ANTI-SCRATCH FINISH
Ensures your rods look great after years of use.



ANTI-FRAP TIP GUIDE
Reduces line wrapping around the tip.



FUJI ALCONITE BKWAG GUIDES
Highest quality Fuji DPS gunsmoke reel seat.



STAINLESS STEEL BUTT CAP
Featuring laser etched logo.



ALPS REEL SEAT
Highest quality, lightweight and incredibly strong.



1-K WEAVE
For added strength and increased tip speed recovery.

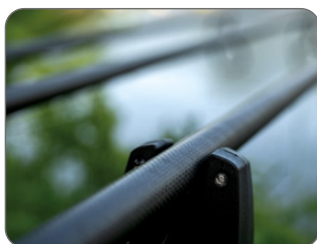

CODE	LENGTH (FT/M)	TEST CURVE (LB)	GUIDE SIZES	OPT. CAST WEIGHT	BARCODE	TRADE PACK
MAGNUM XLR						
ACS170001	13/3.96	3.75	50-40-30-25-20 +16T	120-170g		1



MAGNUM[®]

MAGNUM SPOD & MARKER ROD

- The Magnum Spod and Marker rod has been developed to compliment the Magnum range of rods.
- Fast taper blank perfect for distance marker work.
- Depth markers at 30cm & 50cm.
- Suitable for both Spod & Spombs.
- Will fit in both 12ft & 13ft rod holdalls.
- Weight 425g.



NANO MATRIX CARBON – NMC
Stronger, lighter, Higher Performance Blanks.



ANTI-SCRATCH FINISH
Ensures your rods look great after years of use.



ANTI-FRAP TIP GUIDE
Reduces line wrapping around the tip.



SEA-GUIDE TUXTLSG GUIDES
Highest quality Titanium finish SIC double leg guides.



STAINLESS STEEL BUTT CAP
Featuring laser etched logo.



CARBON CLONE REEL SEAT – 18MM
Ultra lightweight and machined from carbon tube.



1-K WEAVE
For added strength and increased tip speed recovery.

CODE	LENGTH (FT)	TEST CURVE (LB)	GUIDE SIZES	OPT. CAST WEIGHT	BARCODE	TRADE PACK
MAGNUM SPOD & MARKER ROD						
ACS170029	12'6"/3.81	5.00	50-40-30-25-20 + 16T	160g		1



LANDING NETS

LANDING NETS

- NEW** | BLAX X-NET 76
- | BLAX 42" NET 76
- | BLAX 42" MULTI-NET 77
- | MAGNUM X1 42" NET 78
- | MAGNUM X1 42" MULTI-NET 78
- | WATERPROOF LANDING NET PVC BAG 79
- NEW** | BLAX LANDING NET SPARE BLOCK 79
- NEW** | BLAX REPLACEMENT MESH 79
- | LANDING NET FLOAT 79
- | LANDING NET SPARE BLOCK 79

MESHES

- | REPLACEMENT MESH 79



BLAX X-NET NEW AUTUMN 2022

- Outstanding value Landing Net.
- Lightweight 6ft – 180cm Carbon Composite handle.
- 1-piece moulded spreader block.
- Medium depth fish friendly mesh.
- Matt finish handle with minimalist graphics.

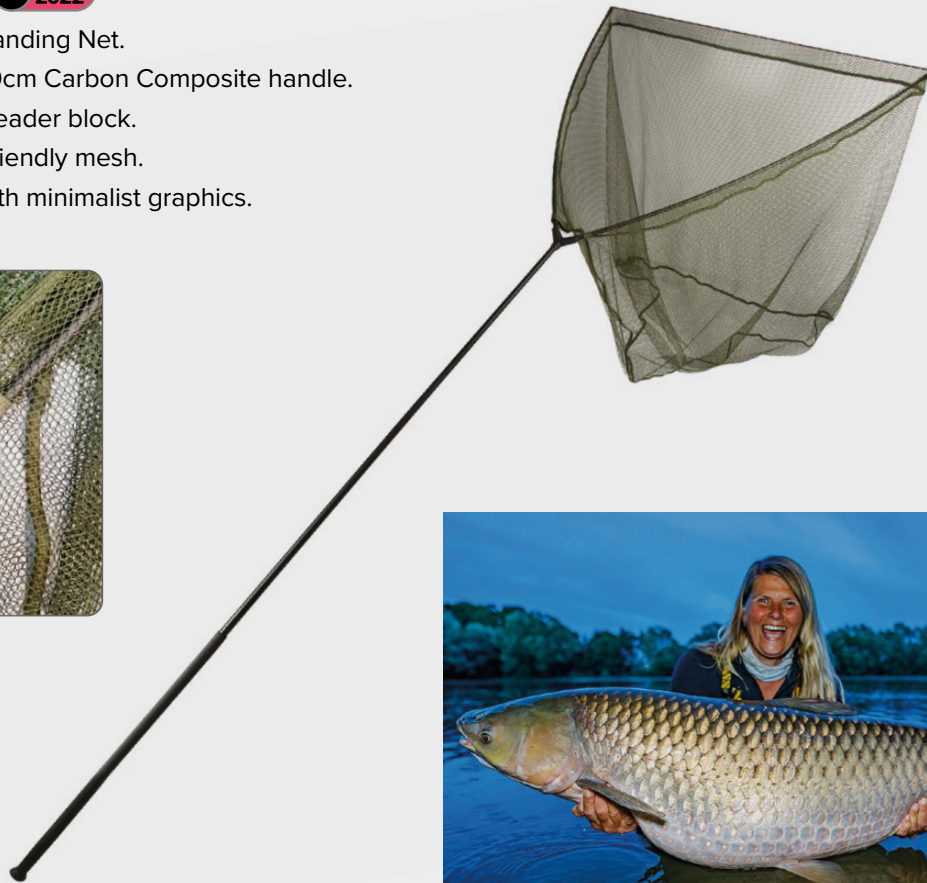

BLAX 6FT 42" LANDING NET

- The BLAX 6ft net has been designed and developed to offer both excellent value and performance.
- Lightweight carbon handle.
- 1 piece lightweight moulded nylon spreader block.
- Anti-slip Japanese shrink wrap handle.
- Anodised Aluminium laser etched butt cap.
- Super soft fish friendly green mesh.
- Rolled Aluminium steel arm ends – Increased strength and easy set up / pack away.
- Mesh clip up magnet – Helps prevent mesh snagging on the bottom.

BEST SELLER





BLAX 42" MULTI-NET

- Built to the same standard as the 6ft BLAX Landing net, the Multi-Net version is all about versatility.
- 3 piece carbon spigot handle.
- Can be used at 3ft (perfect for the boat or tight swims), 6ft or 9ft lengths (perfect for steep banks or zigs).
- 1 piece lightweight moulded nylon spreader block.
- Anti-slip Japanese shrink wrap handle.
- Anodised Aluminium laser etched butt cap.
- Super soft fish friendly green mesh.
- Rolled Aluminium steel arm ends – Increased strength and easy set up / pack away.
- Mesh clip up magnet – Helps prevent mesh snagging on the bottom.

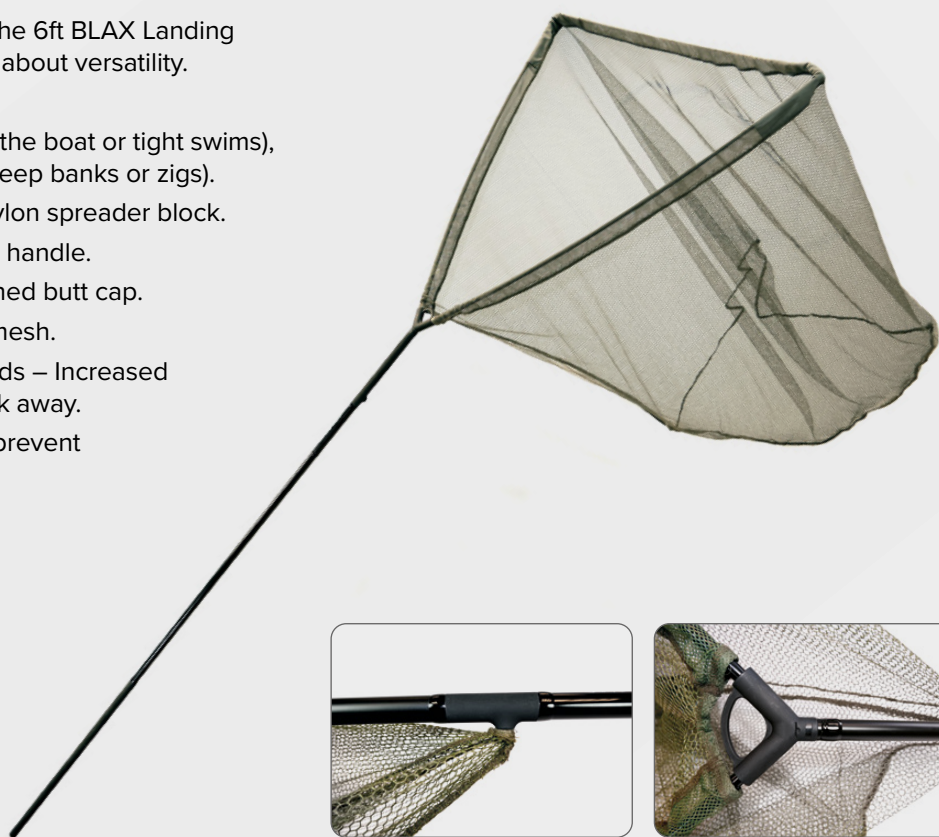

CODE	DIMENSIONS (IN)	DIMENSIONS (CM)	BARCODE	TRADE PACK
BLAX X-NET				
ACS490078	42 x 42	105 x 105		1
BLAX 6FT 42" LANDING NET				
ACS180022	42 x 42	105 x 105		1
BLAX 42" MULTI-NET				
ACS180024	42 x 42	105 x 105		1

MAGNUM X1 6FT 42" LANDING NET

Designed to complement the Magnum range of rods, the X1 net has stunning looks and fantastic performance.

- Hi-modulus light weight carbon handle.
- 1 piece light weight moulded carbon spreader block.
- Anti-slip Japanese shrink wrap handle.
- Stainless steel end cap.
- Super soft fish friendly green mesh.
- Front cord can be quickly and easily replaced / re-tensioned.
- Rolled stainless steel arm ends – Increased strength and easy set up / pack away.
- Mesh clip up magnet – Helps prevent mesh snagging on the bottom.

**MAGNUM X1 42" MULTI NET**

Built to the same standard as the 6ft Magnum X1 Landing net, the Multi-Net version is all about versatility.

- Light weight 3-piece carbon spigot handle.
- Can be used at 3ft (perfect for the boat or tight swims), 6ft or 9ft lengths (perfect for steep banks or zigs).
- 1 piece light weight moulded carbon spreader block.
- EVA end caps included.
- Anti-slip Japanese shrink wrap handle.
- Laser Etched stainless steel butt cap.
- Super soft fish friendly green mesh.
- Front cord can be quickly and easily replaced / re-tensioned.
- Rolled stainless steel arm ends – Increased strength and easy set up / pack away.
- Mesh clip up magnet – Helps prevent mesh snagging on the bottom.



WATERPROOF LANDING NET PVC BAG

- Fully waterproof PVC bag to prevent leakage and odours.



LANDING NET FLOAT

- High density foam for maximum buoyancy.
- Universal fit.



BLAX LANDING NET SPARE BLOCK

- Strong 1 piece moulded construction.
- 3/8 BSF Thread.
- Cross bar design to tuck & hold mesh.
- Accepts net arms up 13mm diameter.



NEW 2023

LANDING NET SPARE BLOCK

- Replacement spreader block compatible with most landing net poles.
- Fitted with a standard 3/8 inch screw thread.



BLAX REPLACEMENT MESH

- Fits all Carp Spirit 42" nets and most other 42" nets.
- Reinforced top stitching.
- Depth 1m.
- Olive green fish friendly material.



NEW 2023

REPLACEMENT MESH

- A high quality replacement mesh. Compatible with Magnum X1 and BLAX landing nets.
- Reinforced top stitching.
- Features screen printed Carp Spirit logo in mesh.
- Super soft and fish friendly.
- Includes stitched magnet for fixing.



CODE	DIMENSIONS (IN)	DIMENSIONS (CM)	BARCODE	TRADE PACK
MAGNUM X1 6FT 42" LANDING NET				
ACS180020	42 x 42	105 x 105		1
MAGNUM X1 42" MULTI NET				
ACS180021	42 x 42	105 x 105		1
WATERPROOF LANDING NET PVC BAG				
ACS070024	—	125		1
BLAX LANDING SPARE BLOCK				
ACS180025	—	—		1
BLAX REPLACEMENT MESH				
ACS180026	42 x 42	105 x 105		1
LANDING NET FLOAT				
154100361	—	—		1
LANDING SPARE BLOCK				
465001360	—	—		1
REPLACEMENT MESH				
ACS180023	42 x 42	105 x 105		1

CARP CARE & WEIGHING

CARP CARE

CARP CRADLES

- NEW | BLAX CRADLE 81
- | NO STRESS CRADLE 81

UNHOOKING MATS

- | ULTRA PROTECTION MAT 81
- | POP UP MAT 82
- | SAFTEY MAT 82

SLINGS AND SACKS

- | BLAX SLING MAT 82
- | FLOATING RETENTION SLING 83
- | RETENTION SACK 83
- | WEIGH SLING 83
- | DELUXE WEIGH SLING 83

WEIGHING

SCALES

- | DELUXE DIAL SCALE 54KG 84
- | DIGITAL SCALE 50KG 84
- | DIAL SCALE 54KG 84

TRIPOD

- | SCALE TRIPOD 84



BLAX CRADLE **NEW AUTUMN 2022**

- Full perimeter padding.
- Waterproof PVC lining.
- Strong and Lightweight Aluminium frame.
- Rubber mesh drainage.
- Rapid set up.
- 360 XL mud feet.
- Folds flat for easy transportation.
- Velcro carry handles.
- Retention overflap with Velcro.



NO STRESS CRADLE

- Designed to offer ultimate protection and safety for the fish.
- Waterproof PVC lining.
- Raised drainage holes to allow for sufficient water retention.
- Fully adjustable legs to help cope with the most challenging of terrains.
- Supplied with a fifth leg for addition support (angler side) when handling the fish and leaning the cradle.
- Compact and rapid set up.
- Supplied with transportation bag.



ULTRA PROTECTION MAT

- High density foam base – maximum protection.
- Rigid & padded walls – prevents fish sliding out.
- Zip down ends for easy fish release.
- Fold away design with carry bag.
- Outer pocket for storing carp care equipment & forceps.
- Rubber mesh base for fast water drainage.
- Wipe clean fish friendly PVC lining.
- Full cover retaining overflap with Velcro securing.



CODE	DIMENSIONS (CM)	WEIGHT (KG)	BARCODE	TRADE PACK
BLAX CRADLE				
ACS070078	100(L) x 60(W) x 38(H)	4.7		1
NO STRESS CRADLE				
ACS070034	128(L) X 70(W)	7.82		1
ULTRA PROTECTION MAT				
ACS070080	112(L) x 68(W) x 26(H)	TBC		1

POP UP MAT

- The Pop-Up Mat has a cleverly designed flexible frame that allows for rapid set up and pack away.
- Rapid set up and pack down.
- Generously padded & compact design.
- Fish friendly wipe clean 40mm base mat.
- Quick dry & self-draining mesh base.
- Reinforced carry straps.
- Raised sides and folder over flap protection.
- Dual anchor points – 2x pegs included.
- Carry bag included.



SAFETY MAT

- Generously padded & compact design.
- Wipe clean fish friendly PVC lining.
- Very good flotation for the release in the water.
- Reinforced carry straps.
- Raised sides and folder over flap protection.



BLAX SLING MAT

- Fish friendly 210D PVC backed nylon.
- Generously padded centre section.
- Full length double zips for easy fish returning.
- Fold out padded kneeling mat.
- Carry handles with scale loops.
- Bag included.



FLOATING RETENTION SLING

- Dual purpose design: weigh and retain.
- Featuring heavy duty zip up sides.
- Rapid drain mesh sections.
- Soft rubber mesh protection.
- High visibility floaters.
- Fitted with a safety snap and a rot resistant cord.



WEIGH SLING

- Carp friendly support.
- Featuring zip up sides and folding Aluminium bars.
- Rapid drain mesh section.
- Safely release all fish.



RETENTION SACK

- Our largest retention sack.
- Fitted with a safety snap and a 2m rot resistant cord.
- Zip up sides.
- Supplied in carry bag.



DELUXE WEIGH SLING

- Strong, carp friendly support.
- Featuring heavy duty zip up sides, velcro secure fixings and folding Aluminium bars.
- Rapid drain mesh section.
- Safely release all fish.



CODE	DIMENSIONS (CM)	WEIGHT (KG)	BARCODE	TRADE PACK
POP UP MAT				
ACS070070	115 x 55 x 30	TBC		1
SAFETY MAT				
948000361	100 x 55 x 25	2.65		1
BLAX SLING MAT				
ACS070079	120 x 80/160	TBC		1
FLOATING RETENTION SLING				
ACS070068	122 x 17 x 64	1.90		1
RETENTION SACK				
030069361	120 x 90	0.56		1
WEIGH SLING				
301001360	120 x 55	0.88		1
DELUXE WEIGH SLING				
689001361	118 x 48	1.20		1

DELUXE DIAL SCALE 54KG

- 54kg x200g / 120lb x 4oz.
- Designed and developed with Reuben Heaton.
- Strong scratch resistant face.
- Oversize stainless-steel hook and loop.
- Generous tare feature – to zero in wet sacks.
- Manufactured in England.
- Padded protection bag included.



DIGITAL SCALE 50KG

- Maximum capacity: 50kg.
- Precision: 50g.
- Measurement units: kg, lbs, st.
- Temperature units: °C and °F.
- LCD screen with 4 digit display.
- Size: 75 x 30mm.



DIAL SCALE 54KG

- A high quality, reliable and robust scale that offers superb value.
- Impact resistant Polycarbonate construction body and lens.
- Calibrated at 200g units and tested to CE standards.
- Padded protection bag included.



SCALE TRIPOD

- Light and stable.
- Telescopic legs for easy storage.
- Supplied with carry bag.



CODE	WEIGHT (KG)	BARCODE	TRADE PACK
DELUXE DIAL SCALE 54KG			
ACS010377	—		1
DIGITAL SCALE 50KG			
125300360	0.7		1
DIAL SCALE 54KG			
ACS010400	1.24		1
SCALE TRIPOD			
124600360	3.8		1

BOATS

BOATS

- | BLACK BOAT ONE 180 **89**
- | BLACK BOAT ONE 230 **89**
- | BLACK BOAT 240WI **92**
- | BLACK BOAT 270WI **92**
- | BLACK BOAT 300WI **93**
- | BLACK BOAT 320W **93**

BOAT ACCESSORIES

- | PUMP BOAT AND FLOAT TUBE **94**
- | REPAIRING KIT BOAT AND FLOAT TUBE **94**
- | QUICK RELEASE BOAT CLIP **94**
- | WATER SCANNER **96**
- | PRODDING STICK **96**



BOATS

BLACK BOAT ONE 180

BLACK BOAT ONE 230



89



89

Product Code	ACS780004	ACS780005
Key USP	PERFECT FOR SMALL WATERS	EXCEPTIONAL PERFORMANCE AND VALUE
Length (cm)	180	230
Width (cm)	124	132
Internal Length (cm)	125	163
Weight (kg)	25	29
Max Power (HP)	2	4
Max Load (kg)	170	350
Max Person	1	2
Material thickness	0.7	0.7
Chamber system	2	3
Floor	Slatted Wood	Slatted Wood
Anti-return inflation valve	●	●
Inflatable keel	—	—
Front cleat	—	—
Side handles	●	●
Rear grab handles	—	—
Oars	●	●
Seat	1	1
Transom with support plate	●	●
Perimeter rope	●	●
Front stainless steel ring	●	●
Storage bag	●	●
Foot pump	●	●
Repair kit	●	●



**BLACK BOAT
240WI**

**BLACK BOAT
270WI**

**BLACK BOAT
300WI**

**BLACK BOAT
320W**

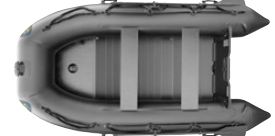
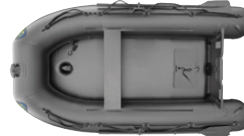

92

92

93

93

ACS780023	ACS780024	ACS780025	ACS780026
GREAT QUALITY, ALL ROUND BOAT	OUR MOST VERSATILE BOAT	HUGE INTERNAL SPACE	AN EXTREME BOAT FOR THE MOST EXTREME CONDITIONS
240	270	300	320
142	154	164	164
173	184	213	213
35	41	44	55
4	10	12	15
350	484	525	566
2	3	4	4
0.9	0.9	0.9	0.9
3+1	3+1	3+1	3+1
Inflatable	Inflatable	Inflatable	Aluminium
●	●	●	●
●	●	●	●
●	●	●	●
●	●	●	●
●	●	●	●
●	●	●	●
●	●	●	●
●	●	●	●
1	1	1	2
●	●	●	●
●	●	●	●
●	●	●	●
●	●	●	●
●	●	●	●
●	●	●	●



BLACK BOAT ONE

Our entry level offering for the inflatable boat range. Featuring 2 models (180 and 230), the Black Boat One is the perfect option for smaller waters and the introductory step into fishing with a boat. The feature packed models include:

- Inflatable chamber system (180: 2 chambers, and 230: 3 chambers).
- Heavy duty 0.7mm canvas with re-enforced side and base for extra protection.

- Slatted floor (width of slat 20cm).
- Removable and adjustable seat.
- Side rope.
- Removable black oars with secure fixing screws.
- Transom with motor support plate.
- Anti- return inflation valves.



THE DETAIL

- 1 Stainless steel ring at the front.
- 2 Slatted floor (width of slat 20cm).
- 3 Removable and adjustable seat.
- 4 Transom with motor support plate.
- 5 Inflation valves with anti-return.
- 6 Heavy duty 0.7mm canvas with re-enforced side and base for extra protection.
- 7 Side rope.
- 8 Removable black oars with secure fixing screws.



Storage bag, large volume foot pump and repair kit included.



BLACK BOAT ONE 180

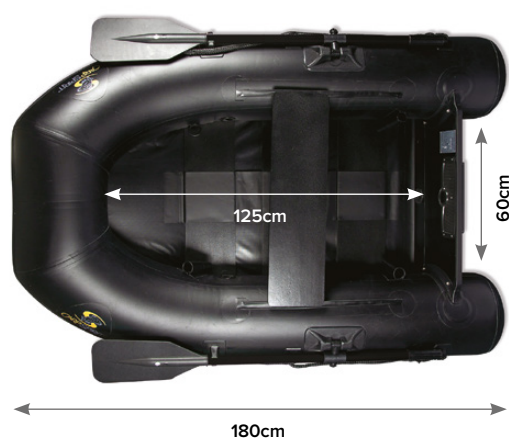

BLACK BOAT ONE 230

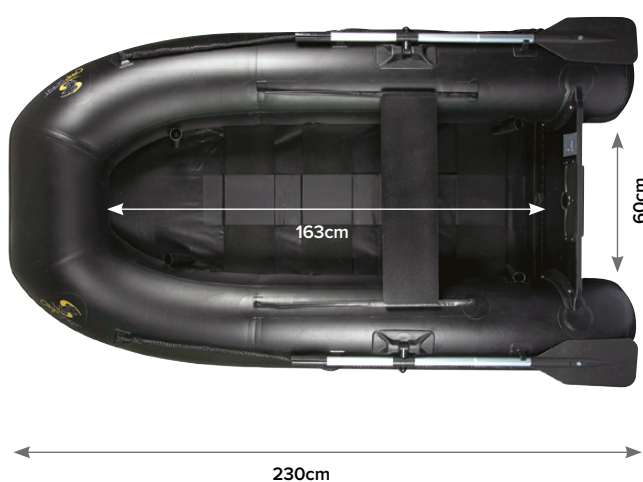

CODE	WEIGHT (KG)	MAX POWER (HP)	MAX LOAD (KG)	MAX PERSON	BARCODE	TRADE PACK
BLACK BOAT ONE 180						
ACS780004	25	2	170	1		1
BLACK BOAT ONE 230						
ACS780005	29	4	350	2		1

BLACK BOAT

When the Black Boat series was first introduced, Carp Spirit became one of the very first brands to produce inflatable boats specifically developed for carp fishing. Now established as a market leader and a benchmark throughout Europe, the latest range of Black Boats have now been improved even further to meet the demands and expectations of the modern-day carp angler.

Packed with new and additional features such as improved inflatable floors, new handles, and increased width to provide even more space and greater stability; all this alongside superb durability to provide years of service. Black Boats... **'The Benchmark'** in carp fishing boats.

- 3+1 Inflatable chamber system.
- Heavy duty 0.9mm canvas with re-enforced side and base for extra protection.
- Inflatable floor (240WI, 270WI & 300WI) with front anti-return valve location. Aluminium floor (320W).
- Built-in floor strengthening ribs for super rigidity.
- Battery protection with strap located at the back.
- Inflatable and reinforced keel cuts through the waves and keeps the nose on course.
- One-way multi point inflation valves.
- Safety overpressure valve.



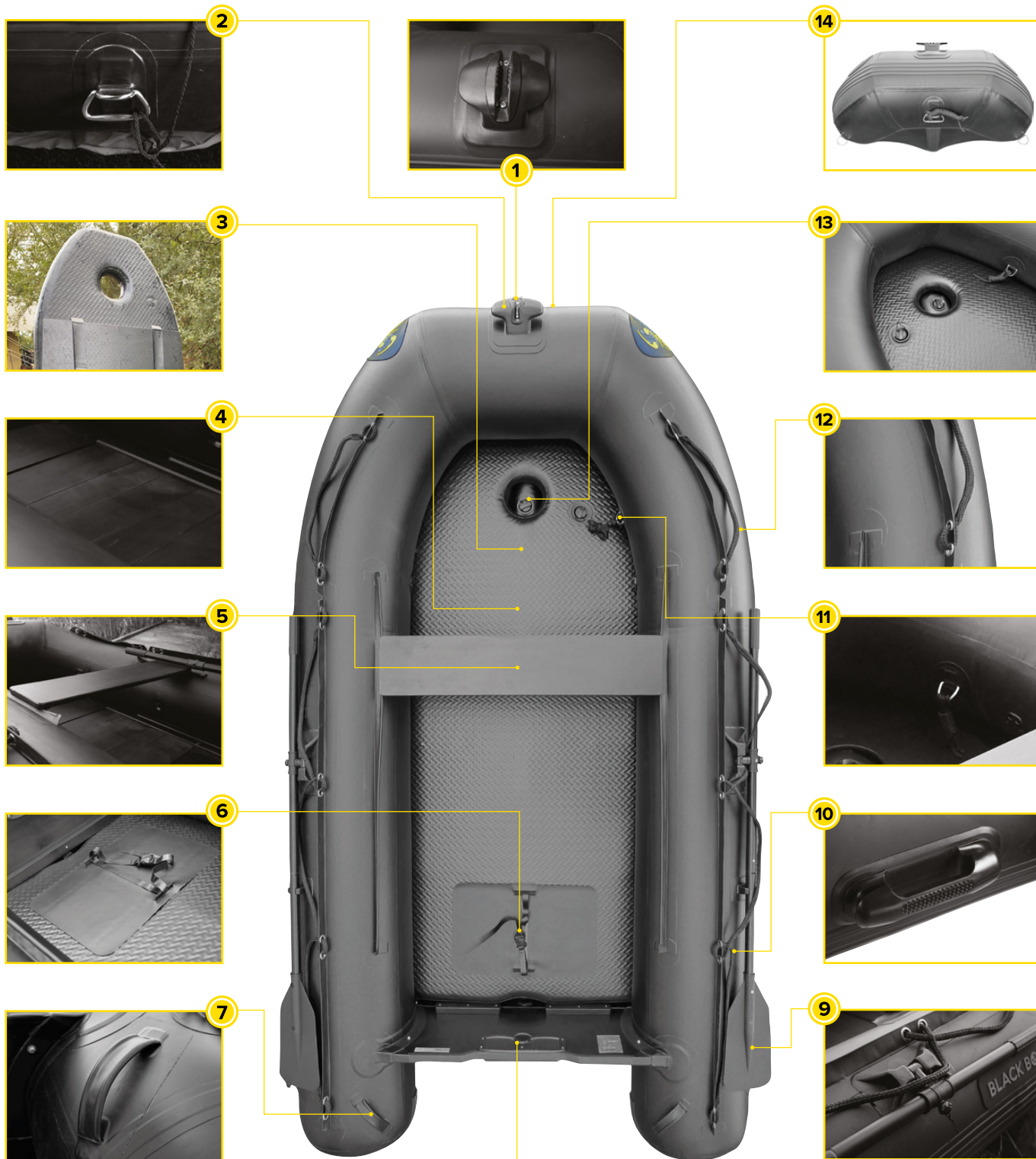

*270WI / 300WI / 320WI

THE DETAIL

- ① Cleat at the front to stabilise the boat, even with one hand.
- ② Stainless steel ring at the front.
- ③ Inflatable floor (240WI, 270WI & 300WI).
- ④ Black Aluminium floor for stability (320W model only).
- ⑤ Removable and adjustable seats.
- ⑥ Battery protection with strap.
- ⑦ Extra strong grab handle on the rear.*
- ⑧ Extra strong transom with motor support plate.
- ⑨ Removable black oars with secure fixing screws.
- ⑩ Side multi-use handles.
- ⑪ Internal stainless ring with fixing cord included.
- ⑫ Side rope.
- ⑬ Floor inflation valve with anti-return.
- ⑭ Inflatable and reinforced keel.

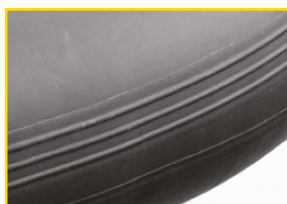

Heavy duty 0.9mm canvas with re-enforced side and base for extra protection.



Storage bag, large volume foot pump and repair kit included.



BLACK BOAT 240_{WI}

Light enough to be moved by 1 person, perfect for baiting, dropping rigs, playing fish with 2 people on board. Shaped to offer great stability – even in bad weather, the 240WI does it all.

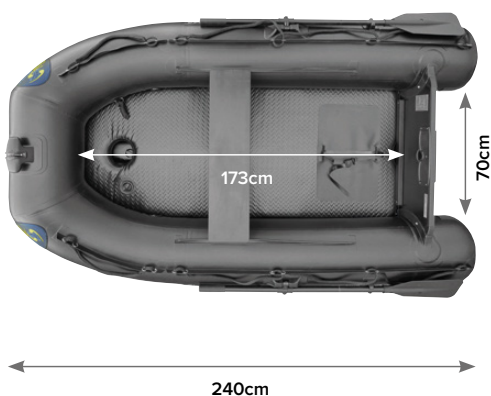

*Inflatable floor.

BLACK BOAT 270_{WI}

The most versatile size of all, very capable in big waters and strong waves, yet still retains excellent manoeuvrability.

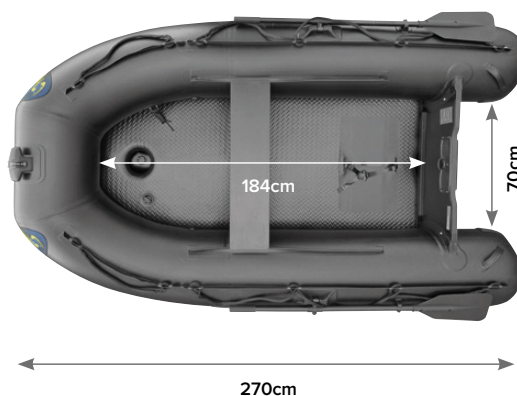

*Inflatable floor.

BLACK BOAT 300_{wi}

With its huge internal space, the 300WI boat is dedicated to large waters and can easily transport an angler and enough equipment for the longest of endurance sessions.

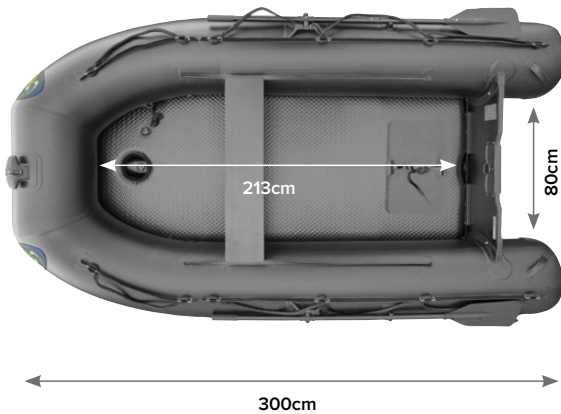

*Inflatable floor.

BLACK BOAT 320_w

An extreme boat for the most extreme conditions, the 320W is built for the most demanding of situations. With its additional pair of moulded front handles, an Aluminium floor, 2 seats and with an engine rating power of up to 15HP, this boat is the perfect tool for any big lake, huge rivers, or even giant catfish fishing. Perfect to move all your equipment from one side of the lake to the other at a moment's notice, whatever the weather; it is even big enough to sleep in.

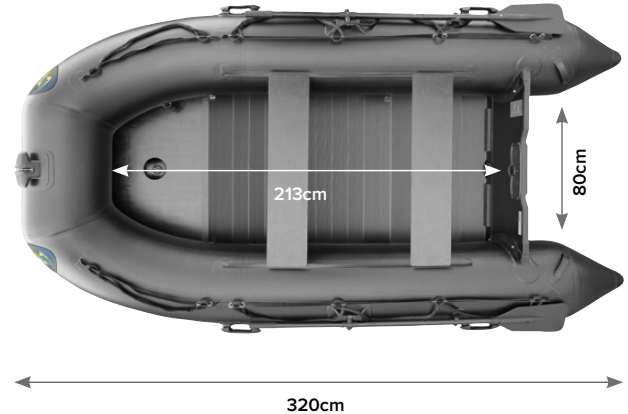

*Aluminium floor.

CODE	WEIGHT (KG)	MAX POWER (HP)	MAX LOAD (KG)	MAX PERSON	BARCODE	TRADE PACK
BLACK BOAT 240WI						
ACS780023	35	4	350	2		1
BLACK BOAT 270WI						
ACS780024	41	10	484	3		1
BLACK BOAT 300WI						
ACS780025	44	12	525	4		1
BLACK BOAT 320W						
ACS780026	55	15	566	4		1

See page 86-87 for detailed dimensions of all Black Boat options.

PUMP BOAT & FLOAT TUBE

- Pump for the Black Boat and Black Boat One range.

**REPAIRING KIT BOAT & FLOAT TUBE**

- Repair Kit for the Black Boat and Black Boat One range.

**QUICK RELEASE BOAT CLIP**

- 1.35m long heavy-duty bungee.
- One hand operation quick release system.
- Hi-Viz puller float.
- Oversize sliding main float – self adjusts.
- Stainless steel construction quick clip.



CODE	DIMENSIONS (CM)	BOAT VERSION	BARCODE	TRADE PACK
PUMP BOAT & FLOAT TUBE				
ACS780009	—	All		1
REPAIRING KIT BOAT & FLOAT TUBE				
ACS780010	—	All		1
QUICK RELEASE BOAT CLIP				
ACS010403	135	All		1



WATER SCANNER

- Perfect for clear waters; helps identify the nature of the bottom and any key features.
- 2 side handles.
- Foldable for space saving and storage.
- Supplied in transport bag.

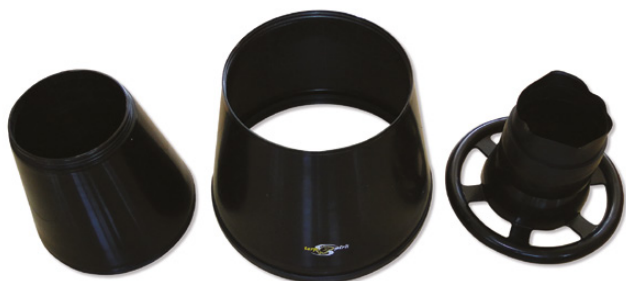
**PRODDING STICK**

- 4.5m three section (1.5m each) pole.
- Help determine the nature of the bottom.
- Supplied with transport bag.



CODE	DIMENSIONS	BARCODE	TRADE PACK
WATER SCANNER			
ACS010208	Transport case – 28cm x 31cm		1
PRODDING STICK			
ACS010019	4.5m		1

HOOKS & READY RIGS

HOOKS

RAZOR POINT HOOKS

- | V-CURVE 99
- | V-CURVE XS 99
- | LONG SHANK 99
- | BOILIE BEAK POINT 100
- | MEDIUM CURVE SHANK 100
- | STIFF RIG / CHOD 100
- | CONTINENTAL XS 100
- | SHORT CURVE SHANK 100
- | ZIG & FLOATER 100

READY RIGS

RAZOR POINT RIGS

- | CHOD RIG 102
- | 360 RIG 102
- | BLOW BACK RIG 102
- | FLUROCARBON D RIG 102
- | PVA BAG HAIR RIG 102
- | KD RIG 102
- | HINGED STIFF RIG 103



RAZOR point

Since their Launch, Razor point hooks have become a firm favourite with Carp Anglers from around the World. With thousands of Carp hooked and safely landed on them, it's easy to see why so many anglers trust and finish their rigs off with our Razor point hooks. Designed from scratch, and tested to the extreme in both in the laboratory and in real world fishing situations by our Global team, you can be confident that whichever Razor Point hook you choose it won't let you down. Attention to detail is everything; each Razor point hook is made to ultra-fine tolerances, carefully tempered using a computer controlled process and chemically sharpened using Durapoint technology. The comprehensive range ensures that whatever angling situation you're faced with, there's a perfect hook pattern for it. We believe our range of Razor point carp hooks are the most technically advanced on the market today – Something we are extremely proud of.

Now with 80% less plastic packaging.

- **Dura-Point Technology** – The sharpest, longest, most durable hooks points in the carp hook World – Even after multiple uses.
- **High Carbon Steel** – Raw material choice is critical, and we only use the best quality high carbon steel available to produce our Razor point carp hooks, providing the very best strength, durability and reliability.
- **PTFE Finish** – The smooth PTFE finish not only reduces glare to avoid spooking wary carp, but also reduces friction, therefore aiding penetration speed by up to 50%.
- **Closed Eye** – Each hook eye is precisely formed to ensure it's truly 'closed' to ensure that zero damage occurs to your hook link, particularly when using the 'knotless knot' and perfect for low diameter hook links or braid.
- **Micro Barb** – Ultra small Micro barbs are designed to offer an extraordinary hook hold during the fight yet minimise mouth damage during unhooking.

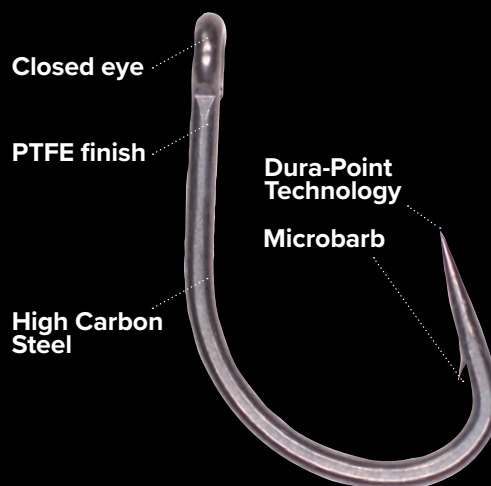

"Sharpest hooks, straight from the packet."

Ian Russell



V-Curve



Long Shank



Boilie Beak Point



Medium Curve Shank



Stiff Rig / Chod



Continental Xtra Strong



Short Curve Shank



Zig & Floater

RAZOR V-CURVE

- Distinct 'V' shaped bend that results in less hook movement and hook pulls.
- The ultrawide gape and short shank provides ultimate penetration.
- In-turned points are perfect for fishing over stones and gravel.

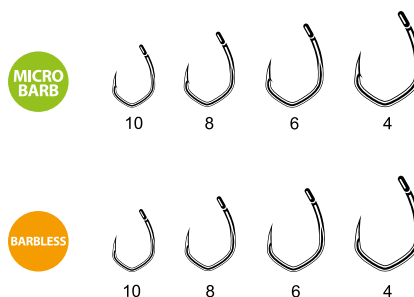

RAZOR V-CURVE XS

- Features a thicker wire gauge than the standard versions, making it 30% stronger, ideal for massive carp or heavy-duty snag fishing.

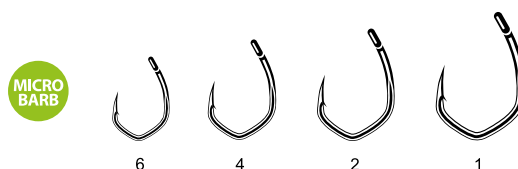

RAZOR LONG SHANK

- Versatile, strong, and reliable, the LS pattern has been designed to cope with a wide variety of carp fishing situations.
- The in-turned eye, straight point and forged shank makes the LS pattern perfectly suited for both hair-rigged bottom baits and pop-up boilies. It is the perfect choice for sliding ring anti-eject rigs.

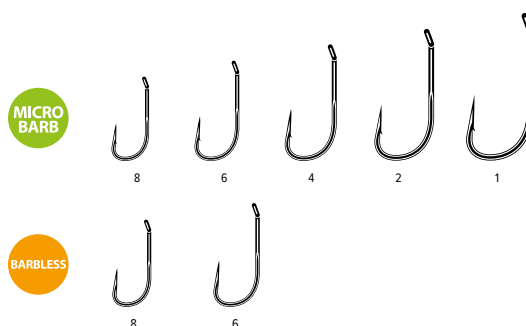

CODE	HOOK SIZE	HOOK TYPE	QUANTITY	BARCODE	TRADE PACK
V-CURVE					
ACS350089	4	Micro Barbed	10	[Barcode]	5
ACS350088	6	Micro Barbed	10	[Barcode]	5
ACS350087	8	Micro Barbed	10	[Barcode]	5
ACS350086	10	Micro Barbed	10	[Barcode]	5
ACS350098	4	Barbless	10	[Barcode]	5
ACS350097	6	Barbless	10	[Barcode]	5
ACS350096	8	Barbless	10	[Barcode]	5
ACS350095	10	Barbless	10	[Barcode]	5
V-CURVE XS					
ACS350093	1	Micro Barbed	10	[Barcode]	5
ACS350092	2	Micro Barbed	10	[Barcode]	5
ACS350091	4	Micro Barbed	10	[Barcode]	5
ACS350090	6	Micro Barbed	10	[Barcode]	5
LONG SHANK					
ACS350028	1	Barbed	10	[Barcode]	5
ACS350029	2	Barbed	10	[Barcode]	5
ACS350030	4	Barbed	10	[Barcode]	5
ACS350032	6	Barbed	10	[Barcode]	5
ACS350034	8	Barbed	10	[Barcode]	5
ACS350036	6	Barbless	10	[Barcode]	5
ACS350037	8	Barbless	10	[Barcode]	5

RAZOR BOILIE BEAK POINT

- With its in-turned beaked point, the BBP is an excellent hook choice when fishing over gravel or rocky bottoms as there is less chance of the hook point becoming damaged.
- The short shank and straight eye has a slight in-turn, making it ideal for a huge array of presentations including snowman rigs, bottom baits or pop-up boilies.

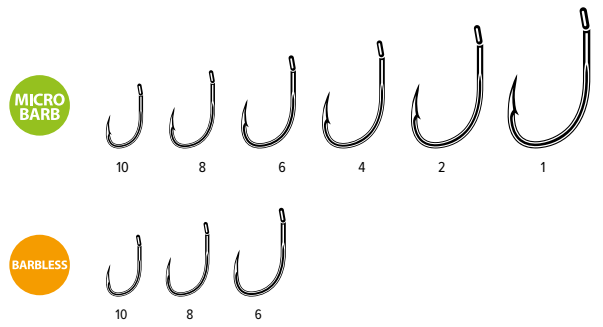

RAZOR MEDIUM CURVE SHANK

- The MCS has been created by combining the benefits of a long shank with the aggressive hooking of a curved style pattern. The slightly downturned eye ensures the hook turns instantly, ready for maximum penetration.
- Suitable for a wide degree of presentations, including the popular '360' and 'Ronnie' style rigs.

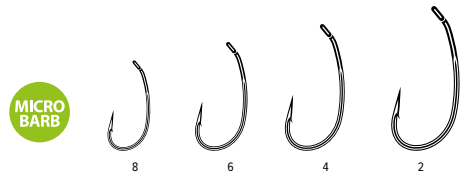

RAZOR STIFF RIG / CHOD

- Specially designed for Chod rigs, the SRC offers the combination of a medium-length shank and out-turned eye to ensure the hook is sits perfectly aligned at all times.
- The closed formed eye is slightly oversized to allow for Snell knots to be used with modern stiff hooklinks and the extra-long, ultra-sharp hook point provides perfect penetration.

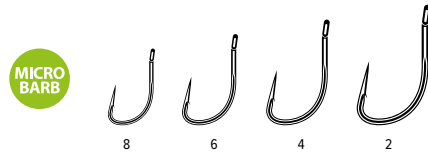

RAZOR CONTINENTAL XS

- The thicker wire gauge of the CXS provides a much stronger hook than normal for the most demanding of situations and has accounted for some of the biggest Carp landed in the World, it is also a great choice for heavy duty snag fishing.
- The short shank and wide gape, makes it ideal for most hair-rig presentations.

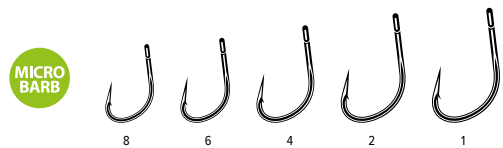

RAZOR SHORT CURVE SHANK

- Our most popular Razor point hook pattern – The SCS is robust, ultra-sharp and incredibly strong. It is also the most versatile, which means it can be used to create a wealth of presentations including hair-rigged bottom baits or pop-up boilies.
- It is the perfect choice for snowman style presentations, Withy pool or a KD style rig.

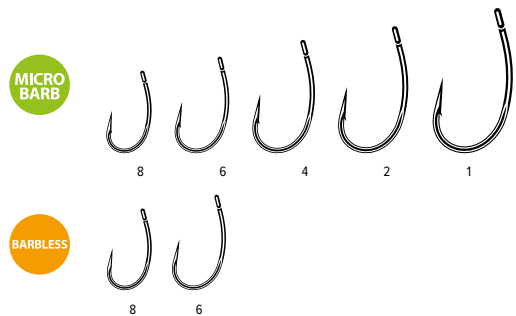

RAZOR ZIG & FLOATER

- Specially designed for zig rigs and floater fishing situation, the short shank and extra wide gape ensures the hook point is in the perfect position to ensure immediate penetration on the take.
- The slightly out-turned eye means the bait is always positioned perfectly in relation to the hook point resulting in more hook ups.



CODE	HOOK SIZE	HOOK TYPE	QUANTITY	BARCODE	TRADE PACK
BOILIE BEAK POINT					
ACS350039	1	Barbed	10		5
ACS350040	2	Barbed	10		5
ACS350041	4	Barbed	10		5
ACS350043	6	Barbed	10		5
ACS350045	8	Barbed	10		5
ACS350046	10	Barbed	10		5
ACS350094	4	Barbless	10		5
ACS350047	6	Barbless	10		5
ACS350048	8	Barbless	10		5
ACS350049	10	Barbless	10		5
MEDIUM CURVE SHANK					
ACS350051	2	Barbed	10		5
ACS350052	4	Barbed	10		5
ACS350054	6	Barbed	10		5
ACS350056	8	Barbed	10		5
STIFF RIG / CHOD					
ACS350058	2	Barbed	10		5
ACS350059	4	Barbed	10		5
ACS350061	6	Barbed	10		5
ACS350063	8	Barbed	10		5
CONTINENTAL XS					
ACS350081	1	Barbed	10		5
ACS350082	2	Barbed	10		5
ACS350083	4	Barbed	10		5
ACS350084	6	Barbed	10		5
ACS350085	8	Barbed	10		5
SHORT CURVE SHANK					
ACS350064	1	Barbed	10		5
ACS350065	2	Barbed	10		5
ACS350066	4	Barbed	10		5
ACS350068	6	Barbed	10		5
ACS350070	8	Barbed	10		5
ACS350072	6	Barbless	10		5
ACS350073	8	Barbless	10		5
ZIG & FLOATER					
ACS350075	8	Barbed	10		5
ACS350076	10	Barbed	10		5
ACS350077	12	Barbed	10		5
ACS350078	8	Barbless	10		5
ACS350079	10	Barbless	10		5
ACS350080	12	Barbless	10		5

RAZOR CHOD RIG

- Constructed using super stiff 25lb Riga-Mortis hooklink, to ensure the shape is retained as much as possible.
- Available in size 4, 6 and 8 barbed versions, at long and short lengths, in packets of three.



MICRO BARB

THE DETAIL

- 1 Razor Point Stiff Rig/Chod Hook.
- 2 25lb Riga-Mortis Hooklink.
- 3 Size 11 Ring Swivel.

RAZOR 360 RIG

- The 360 Rig is regarded as one of the ultimate big fish pop-up rigs.
- The name is derived from the hooks ability to spin a full 360 degrees within the swivel loop, increasing the chances of the hook point getting a hold from whatever angle the fish takes the bait from.

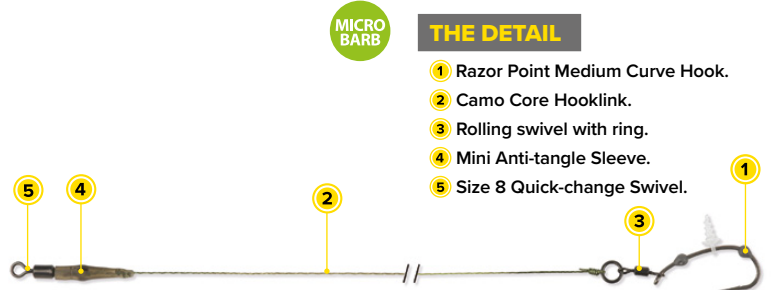

MICRO BARB

THE DETAIL

- 1 Razor Point Medium Curve Hook.
- 2 Camo Core Hooklink.
- 3 Rolling swivel with ring.
- 4 Mini Anti-tangle Sleeve.
- 5 Size 8 Quick-change Swivel.

RAZOR BLOW BACK RIG

- The long shank pattern is perfect for the micro ring to slide along when the fish tries to eject the bait leaving the hook point clear and increasing the chances of finding a hold.
- A Carp Spirit Kicker line aligner is also added to the rig to aid rapid turning of the hook point.
- This versatile rig is perfect for use with both bottom baits and pop-ups.

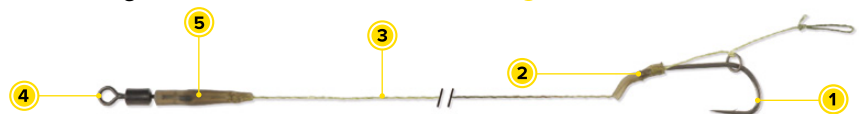

MICRO BARB

THE DETAIL

- 1 Razor Point Long Shank Hook.
- 2 Kicker Line Aligner.
- 3 Camo Core Hooklink.
- 4 Size 8 Quick-change Swivel.
- 5 Mini Anti-tangle Sleeve.

RAZOR FLUOROCARBON 'D' RIG

- With Fluorocarbon having similar light refractive properties to water and no tubing present, the rig almost disappears when immersed in water.
- The Fluorocarbon 'D' rig is perfect for bottom baits, slow sinkers or snowman style setups.

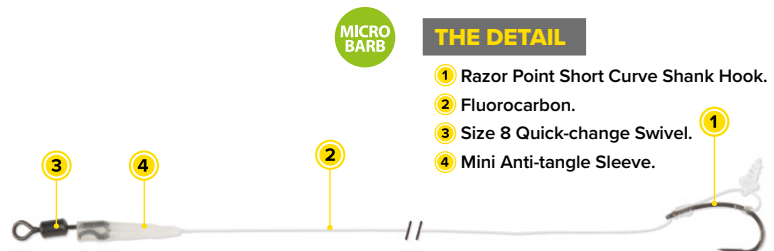

MICRO BARB

THE DETAIL

- 1 Razor Point Short Curve Shank Hook.
- 2 Fluorocarbon.
- 3 Size 8 Quick-change Swivel.
- 4 Mini Anti-tangle Sleeve.

RAZOR PVA BAG HAIR RIG

- PVA Bag Rigs are short, braided rigs specifically designed for use with PVA Bags.
- Can easily be dropped directly into solid PVA bags or can be used in conjunction with PVA Mesh systems.

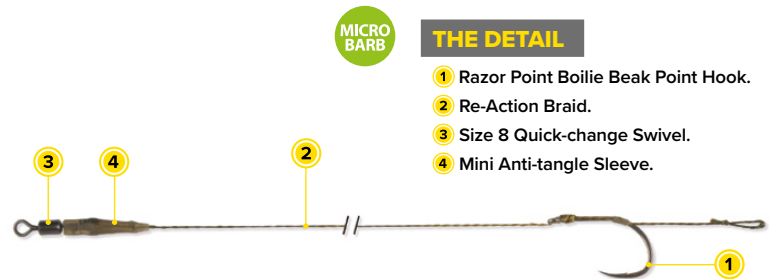

MICRO BARB

THE DETAIL

- 1 Razor Point Boilie Beak Point Hook.
- 2 Re-Action Braid.
- 3 Size 8 Quick-change Swivel.
- 4 Mini Anti-tangle Sleeve.

RAZOR KD RIG

- Best fished with slow sinking critically balanced baits or a pop-up with a small split shot directly under the bait to act as a counterbalance.
- The hook retains an incredible amount of free movement making this a very effective rig that is renowned for good hook holds.

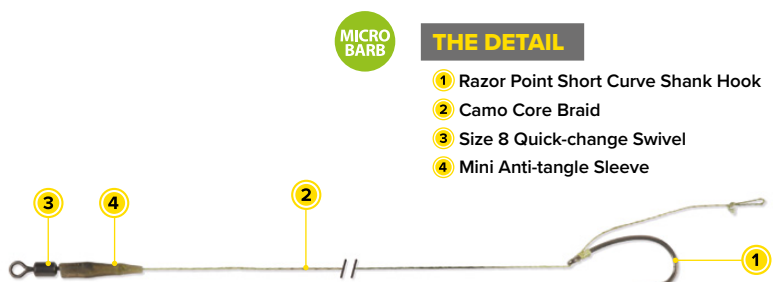

MICRO BARB

THE DETAIL

- 1 Razor Point Short Curve Shank Hook
- 2 Camo Core Braid
- 3 Size 8 Quick-change Swivel
- 4 Mini Anti-tangle Sleeve

RAZOR HINGED STIFF RIG

- The Hinged Stiff Rig is a popular choice due to its excellent hooking efficiency and anti-tangle properties.
- A Razor Point SRC (Stiff Rig Chod) hook is used due to its oversized and slightly in-turned eye to give perfect presentation.

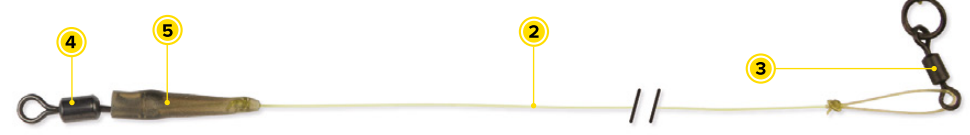

MICRO BARB

THE DETAIL

- ① Razor Point Stiff Rig/Chod Hook.
- ② Riga-Mortis Hooklink.
- ③ Rolling swivel with ring.
- ④ Size 8 Quick-change Swivel.
- ⑤ Mini Anti-tangle Sleeve.

CODE	LENGTH (CM)	BREAKING STRAIN (LB)	HOOK SIZE	SWIVEL SIZE	PACK QUANTITY	BARCODE	TRADE PACK
CHOD RIG							
ACS340023	8.25	25	4	11	3		5
ACS340025	8.25	25	6	11	3		5
ACS340027	8.25	25	8	11	3		5
ACS340028	5.75	25	4	11	3		5
ACS340030	5.75	25	6	11	3		5
ACS340032	5.75	25	8	11	3		5
360 RIG							
ACS340034	—	25	4	8	1		5
ACS340035	—	20	6	8	1		5
ACS340036	—	20	8	8	1		5
BLOW BACK RIG							
ACS340045	—	25	4	8	1		5
ACS340046	—	20	6	8	1		5
ACS340047	—	20	8	8	1		5
FLUOROCARBON 'D' RIG							
ACS340050	—	25	2	8	1		5
ACS340051	—	25	4	8	1		5
ACS340052	—	25	6	8	1		5
ACS340053	—	25	8	8	1		5
PVA BAG HAIR RIG							
ACS340057	—	20	2	8	2		5
ACS340058	—	20	4	8	2		5
ACS340059	—	20	6	8	2		5
ACS340060	—	20	8	8	2		5
KD RIG							
ACS340064	—	25	2	8	2		5
ACS340065	—	25	4	8	2		5
ACS340066	—	20	6	8	2		5
ACS340067	—	20	8	8	2		5
HINGED STIFF RIG							
ACS340038	—	25+20	4	8	1		5
ACS340039	—	25+15	6	8	1		5
ACS340040	—	25+15	8	8	1		5



MAINLINE, LEADERS & HOOKLINKS

MAINLINE & SHOCKLEADERS

MONOFILAMENT MAINLINE

| VELOCITY™ XS 106

| CELT-2X™ 106

| M-TX™ 106

BRAIDED MAINLINE

| 4D™ 107

SPOD & MARKER™ BRAIDED MAINLINE

| SPOD & MARKER BRAID™ 107

SHOCKLEADERS

| VELOCITY™ TAPERED LEADER 109

| DRESSEN-X™ 109

ACCESSORIES

| CASTING GLOVE – RIGHT HAND 110

| LINE REMOVER 110

| D-SPOOL STRIPPER 110

LEADCORE & LEADERS

| CAMO WEED LEADCORE 110

| GRAVITY™ UHL 111

| GRAVITY™ SSL 111

| GRAVITY™ LFL 111

| GRAVITY™ SPLICED LEADER 112

LEADCORE LEADERS

| CAMFUSION LEADER 112

| FLUORO LEADER 112

HOOKLINKS

| OPTI-MEX™ 112

| BALLISTIC™ 113

| RIGA-MORTIS™ 113

| RE-ACTION™ 114

| HERCULINE™ 114

| KAMELEON 114

| COMBI-STIFF™ 114

| ZIG-MASTER™ 114

| COMBI-SOFT™ 114

| BAIT FLOSS™ 115



VELOCITY™ XS – MONOFILAMENT MAINLINE

- Our highest quality, extra-strong, premium monofilament designed and developed specifically for carp fishing.
- The unique co-polymer formulation results in excellent abrasion resistance yet still retains a high breaking strain to diameter ratio.
- Soft, supple line that sinks fast.



CELT-2X™ – MONOFILAMENT MAINLINE

- Carp Spirit Celt-2X™ mainline is incredibly smooth and supple.
- Featuring a unique lo-friction silicone-based coating to aid casting distance; this also improves line lay on the reel.
- The proven formula has remained unchanged, resulting in controlled elasticity and stretch, excellent abrasion resistance and superb knot strength.



MT-X™ – MONOFILAMENT MAINLINE

- M-TX™ is a good quality monofilament that's also excellent value.
- Features a super smooth finish for enhanced abrasion resistance and high knot strength.
- M-TX™ is available in both Green and Black colours to suit a range of fishing conditions.





CODE	LENGTH (M)	DIAMETER (MM)	BREAKING STRAIN (KG)	BREAKING STRAIN (LB)	BARCODE	TRADE PACK
VELOCITY™ XS LO-VIS GREEN						
ACS470034	1200	0.25	5.0	11.0		3
ACS470035	1200	0.27	5.9	13.0		3
ACS470036	1200	0.30	7.0	15.5		3
ACS470037	1200	0.35	8.5	19.0		3
ACS470038	1200	0.40	11.8	26.0		3
VELOCITY™ XS LO-VIS BROWN						
ACS470040	1200	0.25	5.0	11.0		3
ACS470041	1200	0.27	5.9	13.0		3
ACS470042	1200	0.30	7.0	15.5		3
ACS470043	1200	0.35	8.5	19.0		3
ACS470044	1200	0.40	11.8	26.0		3
VELOCITY™ XS LO-VIS CAMO						
ACS470075	1200	0.27	5.9	13.0		3
ACS470076	1200	0.30	7.0	15.5		3
ACS470077	1200	0.35	8.5	19.0		3
ACS470078	1200	0.40	11.8	26.0		3
CELT-2X™ HI-VIS GREEN						
ACS470016	1600	0.26	5.4	12.0		3
ACS470017	1400	0.285	6.45	14.0		3
ACS470018	1200	0.31	7.60	16.5		3
ACS470019	1000	0.35	10.65	23.5		3
MT-X™ BLACK						
ACS470058	1410	0.25	4.9	11.0		6
ACS470059	1410	0.28	5.9	13.0		6
ACS470060	1410	0.30	7.0	15.5		6
ACS470061	1020	0.35	9.5	21.0		6
ACS470062	790	0.40	10.5	23.0		6
MT-X™ GREEN						
ACS470063	1410	0.30	7.0	15.5		6
ACS470064	1020	0.35	9.5	21.0		6
ACS470065	790	0.40	10.5	23.0		6

4D – CAMO BRAID

- Made from Dyneema® / polyester blend resulting in a tremendous balance of value and performance.
- The 4 camouflage colours along its length help break up the shape to blend into the lakebed.
- Fast sinking, durable and highly abrasion resistant, the special twist construction provides exceptional sensitivity making 4D™ Camo Braid perfect for carp fishing.



SPOD & MARKER X4 – BRAID

- Excellent value Hi-Viz braid, that is tough and durable to withstand the repetitive casting that spoding and feature finding requires.
- Zero stretch reduces 'springs back' when a spool line clip is used, and feedback is greatly enhanced when using a feature finding lead to map out the lake bed.



SPOD & MARKER X8 – BRAID

- Features a super smooth profile. The low diameter 8 carrier construction reduces friction and noise through the rod guides to aid distance and accuracy.
- Specifically developed to be tough and durable to withstand the repetitive casting that spoding and feature finding requires.
- Zero stretch reduces 'springs back' when a spool line clip is used, and feedback is greatly enhanced when using a feature finding lead to map out the lake bed.



VELOCITY – TAPERED LEADERS

- Each leader is 15m long. The front 5m is parallel, followed by a 6m tapered middle section and then a 4m parallel section at the end. If required, the tapered section can be simply trimmed back to increase the diameter before being knotted to the mainline.

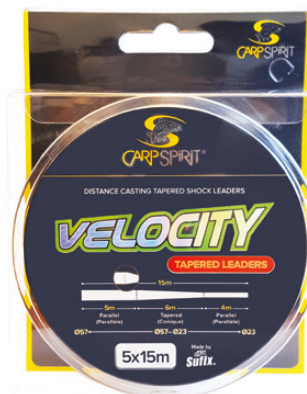

DRESSEN-X – SHOCKLEADER

- Made from a special polyamide copolymer, Dressen-X™ offers outstanding abrasion resistance against mussels, rocks, and gravel bars.
- It also retains a degree of stretch to help absorb the lunges during the crucial time of the when the fish is under the rod tip.



CODE	LENGTH (M)	DIAMETER (MM)	BREAKING STRAIN (KG)	BREAKING STRAIN (LB)	BARCODE	TRADE PACK
4D CAMO BRAID						
ACS640018	300	0.26	15.0	33.0		1
ACS640019	300	0.30	17.0	37.5		1
ACS640020	300	0.35	18.4	40.5		1
ACS640021	1000	0.26	15.0	33.0		1
ACS640022	1000	0.30	17.0	37.5		1
ACS640023	1000	0.35	18.4	40.5		1
SPOD & MARKER X4 – YELLOW						
ACS640087	300	0.20	13.6	30		1
SPOD & MARKER X8 – ORANGE						
ACS640017	300	0.20	13.6	30		1
SPOD & MARKER X8 – BLACK						
ACS640016	300	0.20	13.6	30		1
VELOCITY™ TAPERED LEADERS						
ACS470079	5 x 15	0.23-0.57	—	—		3
DRESSEN-X – GREEN						
ACS470032	100	0.40	10.34	23.0		3
550048015	100	0.50	15.73	35.0		3
560048015	100	0.60	22.00	48.5		3
570048015	100	0.70	27.50	60.5		3
580048015	100	0.80	34.00	75.0		3
DRESSEN-X – BLACK						
050045139	100	0.50	15.73	35.0		3

CASTING GLOVE – RIGHT HAND

- Made from thin and flexible neoprene making it exceptionally comfortable to wear.



D-SPOOL STRIPPER

- Designed to be used with a cordless drill.
- Features a safety clutch in the event of the line becoming snagged whilst stripping.
- After all the line is stripped, simply untwist the cap to release the old line for disposal.



LINE REMOVER

- Perfect tool for quickly and effortlessly emptying high-capacity big pit reel spools.
- Removes line at up to 4 m/sec.
- High speed 2,700 rpm motor.
- Requires 4 x AA batteries (not included).



CAMO WEED – LEAD CORE LEADER

- The ultimate in leader camouflage.
- Not only will Camo Weed Leadcore blend into almost any lakebed, the dense lead centre will keep it pinned down tight to the bottom and the separate braided inner makes it easy to splice.



GRAVITY UHL – SOFT LEADCORE

- Gravity™ UHL is our heaviest leadcore leader.
- Perfect for fishing chod rigs, its super dense properties mean that there is no need for additional rig putty to ensure the leader is pinned down tight to the bottom.
- Easy to splice.

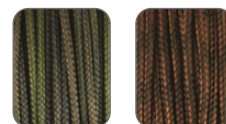

GRAVITY SSL – HEAVY LEADCORE

- Gravity™ SSL is a ‘super supple leader’ that features a high density leadcore inner.
- Its supple characteristics allow the leader to follow the contours of the lakebed ensuring it is well hidden from spooky carp.
- Easy to splice.

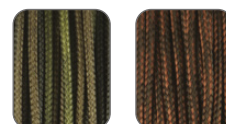

GRAVITY LFL – LEAD FREE LEADER

- Gravity™ LFL is a new generation of Lead-Free Leader.
- Constructed from fast sinking high density PTFE fibre. LFL is incredibly supple allowing it to perfectly follow the contours of the lakebed ensuring it's well hidden from spooky carp; can be knotted if required.
- Easy to splice.

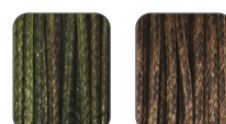

CODE	LENGTH (M)	BREAKING STRAIN (KG)	BREAKING STRAIN (LB)	BARCODE	TRADE PACK
CASTING GLOVE – RIGHT HAND					
ACS010381	—	—	—		1
LINE REMOVER					
ACS010378	—	—	—		1
D-SPOOL STRIPPER					
ACS010222	—	—	—		5
CAMO WEED LEAD CORE					
ACS640014	5	20.40	45.0		3
GRAVITY UHL CAMO GREEN					
ACS640044	10	20.40	45.0		3
GRAVITY UHL CAMO BROWN					
ACS640045	10	20.40	45.0		3
GRAVITY SSL CAMO GREEN					
ACS640046	10	20.40	45.0		3
GRAVITY SSL CAMO BROWN					
ACS640047	10	20.40	45.0		3
GRAVITY LFL CAMO GREEN					
ACS640048	10	18.1	40		3
GRAVITY LFL CAMO BROWN					
ACS640049	10	18.1	40		3

GRAVITY – SPLICED LEADCORE LEADERS

- A full range of readymade Leadcore Leaders.
- Individually tested and carefully hand spliced.
- Made with our Gravity™ UHL leadcore.
- 3 per pack.



CAMFUSION® LEADER

- Camfusion® leaders offer the ultimate in rig camouflage.
- Translucent, with hint of green, the Camfusion® colour still allows a degree of natural light to pass through the leader so that it can blend in with the natural colour of the lakebed.
- Un-like traditional rig tubing, Camfusion® leaders are a solid sinking construction, which means there is no room for air bubbles to get trapped inside, whilst the smooth welded loops reduce tangles, and the diameter ensures they are fish friendly during the fight.
- Available in both standard and ring swivel versions.



FLUORO LEADER

- Fluoro leaders are particularly well suited for fishing in bright conditions, in clear water and when the fish are known for spooking off the rig area.
- Being transparent, natural light can pass through the leader so that it can blend in with the natural colour of the lakebed.
- Un-like traditional rig tubing, Fluoro leaders are a solid sinking construction, which means there is no room for air bubbles to get trapped inside, whilst the smooth welded loops reduce tangles, and the diameter ensures they are fish friendly during the fight.
- Available in both standard and ring swivel versions.



OPTI-MEX – FLUOROCARBON HOOKLINK

- Opti-Mex™ is made from 100% fluorocarbon which due its light refractive properties is virtually invisible in water and sinks 4 times faster compared to standard nylon line.
- With its low stretch and incredible abrasion resistance, Opti-Mex™ is the perfect choice for the most demanding of fishing situations that require the best possible presentation.



RIGA-MORTIS – CHOD HOOKLINK

- The ultra-high memory ensures that the shape of your chod rig is retained during the cast.
- It can easily be curved between your thumb and forefinger or straightened by simply stretching between two multi-pull tools.



BALLISTIC – SNAG & LEADER BRAID

- Ballistic™ is an extremely strong and supple braid with neutral buoyancy and ultra-high abrasion resistance.
- Perfect for shock and snag leaders when fishing in extreme snaggy conditions.



CODE	TYPE	LENGTH	BREAKING STRAIN (KG)	BREAKING STRAIN (LB)	BARCODE	TRADE PACK
GRAVITY SPLICED LEADCORE LEADERS						
ACS010148	Loop to Swivel	90cm	—	—		5
ACS010149	Lead Clip	90cm	—	—		5
ACS010150	Metallic Lead Clip	90cm	—	—		5
ACS010151	Helicopter	90cm	—	—		5
CAMFUSION LEADER						
ACS340081	Ring Swivel	100cm	—	45		5
ACS340082	Rolling Swivel	100cm	—	45		5
FLUORO LEADER						
ACS340083	Ring Swivel	100cm	—	45		5
ACS340084	Rolling Swivel	100cm	—	45		5
OPTI-MEX FLUOROCARBON						
ACS640039	—	20m	8.20	18.0		3
ACS640040	—	20m	10.50	23.0		3
ACS640041	—	20m	14.80	32.5		3
ACS640042	—	20m	17.00	37.5		3
ACS640043	—	20m	19.00	42.0		3
RIGA-MORTIS CAMO GREEN						
ACS640053	—	20m	6.80	15		3
ACS640054	—	20m	9.10	20		3
ACS640055	—	20m	11.30	25		3
BALLISTIC – SNAG & LEADER BRAID CAMO GREEN						
ACS640033	—	20m	11.30	25		3
ACS640034	—	20m	15.90	35		3
ACS640035	—	20m	20.40	45		3
BALLISTIC – SNAG & LEADER BRAID CAMO BROWN						
ACS640036	—	20m	11.30	25		3
ACS640037	—	20m	15.90	35		3
ACS640038	—	20m	20.40	45		3

RE-ACTION – FAST SINKING BRAID

- Re-Action™ braid is a fast sinking, super soft, supple braid for hook lengths and particularly ideal for PVA bag presentation.
- Made from a blend of dyneema and polyester Re-Action™ has superb knot strength and abrasion resistance.

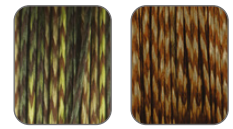

HERCULINE – SLOW SINKING BRAID

- Herculine™ blend is a slow sinking braid.
- This extremely soft hooklink is perfect for all rig presentations including super supple rigs to be used in solid PVA bags.



KAMELEON – SOFT COATED HOOKLINK

- Kameleon features multiple colours along its length for the ultimate in hooklink camouflage.
- A fast sinking, soft coated braid, ideal for combi link rigs or can be used un-stripped to create a semi rigid hooklink.



COMBI-STIFF – STIFF COATED HOOKLINK

- A fast sinking, stiff coated braid, Combi-Stiff™ is particularly well suited to clean lake beds.
- Simply use a strip-eaze tool to remove the desired amount of coating to make the perfect combi or hinge style rigs.

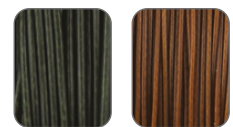

ZIG-MASTER – ZIG & FLOAT LINE

- Zig-Master™ line is a Lo-Vis clear monofilament Hooklink that's been specially developed for Zig rig presentations and floater fishing. The low stretch and neutral buoyancy make it ideal for presenting mid-water baits when using Zig rigs or floating surface baits.
- High knot strength and low diameter to breaking strain to ratio.



COMBI-SOFT – SOFT COATED HOOKLINK

- A fast sinking, soft coated braid, ideal for combi link rigs or can be used un-stripped to create a semi rigid hooklink.
- Simply use a strip-eaze tool to remove the desired amount of coating to make the perfect combi or hinge style rigs.



BAIT FLOSS

- Bait floss – An essential item that is perfect for tying on pop-ups.
- Perfect for tying on smooth and hard pop-ups.
- Flat profile and wax finish to grip baits securely.



CODE	LENGTH (M)	BREAKING STRAIN (KG)	BREAKING STRAIN (LB)	BARCODE	TRADE PACK
REACTION CAMO GREEN					
ACS640058	20	6.80	15	[Barcode]	3
ACS640059	20	9.10	20	[Barcode]	3
ACS640060	20	11.30	25	[Barcode]	3
ACS640061	20	15.90	35	[Barcode]	3
REACTION CAMO BROWN					
ACS640062	20	6.80	15	[Barcode]	3
ACS640063	20	9.10	20	[Barcode]	3
ACS640064	20	11.30	25	[Barcode]	3
ACS640065	20	15.90	35	[Barcode]	3
HERCULINE CAMO GREEN					
ACS640066	20	6.80	15	[Barcode]	3
ACS640067	20	9.10	20	[Barcode]	3
ACS640068	20	11.30	25	[Barcode]	3
HERCULINE CAMO BROWN					
ACS640069	20	6.80	15	[Barcode]	3
ACS640070	20	9.10	20	[Barcode]	3
ACS640071	20	11.30	25	[Barcode]	3
KAMELEON					
ACS640092	20	9.10	20	[Barcode]	3
ACS640093	20	11.30	25	[Barcode]	3
ACS640094	20	15.90	35	[Barcode]	3
COMBI-STIFF CAMO BROWN					
ACS640072	20	6.80	15	[Barcode]	3
ACS640073	20	11.30	25	[Barcode]	3
COMBI-STIFF CAMO GREEN					
ACS640074	20	6.80	15	[Barcode]	3
ACS640075	20	11.30	25	[Barcode]	3
ZIG-MASTER					
ACS470080	110	0.23	8	[Barcode]	3
ACS470081	110	0.25	10	[Barcode]	3
ACS470082	110	0.28	12	[Barcode]	3
COMBI-SOFT CAMO BROWN					
ACS640078	20	9.10	20	[Barcode]	3
ACS640079	20	11.30	25	[Barcode]	3
ACS640080	20	15.90	35	[Barcode]	3
COMBI-SOFT CAMO GREEN					
ACS640081	20	9.10	20	[Barcode]	3
ACS640082	20	11.30	25	[Barcode]	3
ACS640083	20	15.90	35	[Barcode]	3
BAIT FLOSS					
ACS010390	50	—	—	[Barcode]	3

RIG TOOLS

BAITING NEEDLES, BAIT DRILLS & HAIR STOPS

- | STRINGER NEEDLE 117
- | BRAID & HARD BAIT NEEDLE 117
- | HEAVY LIP CLOSE NEEDLE 117
- | FINE LIP CLOSE NEEDLE 117
- | STICK & STRING NEEDLE 117
- | MAGGOT & ULTRA FINE BAIT NEEDLE 118
- | ALL PURPOSE NEEDLE SET 118
- | STICK & STRING NEEDLE SET 118
- | BAIT DRILL 118
- | BOILIE DRILL 118
- | BOILIE STOP 118
- | CORN BOILIE STOPS 118
- | BOILIE HAIR EXTEND 118
- | HAIR EXTENDER STOP 119
- | BOILIE STOP CAP 119

PULL & STRIP TOOL

- | STRIP-EAZE TOOL 120

SCISSORS & PLIERS

- | CUTTING PLIERS 120

STRINGER NEEDLE

- Designed for making PVA stringers, its pointed crook ensures the string or tape is held securely whilst feeding baits off the needle.

**BRAID & HARD BAIT NEEDLE**

- Perfect for use with braided hairs, the open needle reduces hair damage, and the point is perfect for hard baits such as tiger nuts or air-dried boilies.

**HEAVY LIP CLOSE NEEDLE**

- This 'all round' needle is suitable for most particle and boilie baits.
- The hinged gate securely holds the hair whilst sliding the bait up into position and is also a great little tool for tying small loops in short hairs.

**FINE LIP CLOSE NEEDLE**

- Designed for use with small boilies or soft baits, the fine wire hook greatly reduces the chance of splitting the bait.
- Also ideal for splicing leadcore or threading on fine silicone tubing onto braid.

**STICK & STRING NEEDLE**

- Designed primarily for threading hooklinks through PVA mesh sticks, the hinged gate closes to ensure that the hook does not catch or damage the mesh whilst pulling the needle through.
- Also perfect for making PVA stringers.



CODE	BARCODE	TRADE PACK
STRINGER NEEDLE		
ACS010262		5
BRAID & HARD BAIT NEEDLE		
ACS010263		5
HEAVY LIP CLOSE NEEDLE		
ACS010264		5
FINE LIP CLOSE NEEDLE		
ACS010265		5
STICK & STRING NEEDLE		
ACS010266		5

MAGGOT & ULTRA FINE BAIT NEEDLE

- Ideal for use with fine line or braided hairs, the ultra-fine pointed and hardened stainless steel needle reduces the chances of splitting fragile baits such as maggots or corn.

**ALL PURPOSE NEEDLE SET**

- Colour coded set covering every possible angling situation.

This pack contains:

1x Heavy Lip Close Needle (Yellow)

1x Braid & Hard Bait Needle (Orange)

1x Maggot / Ultra Fine Needle (Magenta)

1x Fine Lip Close Splicing Needle (Blue)

**STICK & STRING NEEDLE SET**

- Colour coded set covering every possible angling situation.

This pack contains:

1x Stick & String Needle (Green)

1x Stringer Needle (Red)

**BAIT DRILL**

- 1.2mm stainless steel drill
- Perfect for drilling out hard baits such as air-dried boilies or pellets.

**BOILIE DRILL**

- 6mm boilie drill.
- Perfect for drilling boilies or large particles such as tiger nuts, so that Buoyant foam or cork sticks can be inserted to make them float.

**BOILIE STOP**

- Designed to fit snugly against the curved surface of any size of boilie, these discreet buoyant bait stops will securely hold the hair in place.

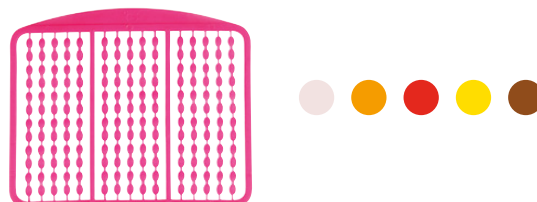
**CORN BOILIE STOPS**

- Floating imitation Corn Bait Stops provide an excellent visual aid when used with a boilie.
- The 2 hook lengths allow for that diameter of the boilie to be changed without having to change the length of the hair.

**BOILIE HAIR EXTENDER**

- Designed to allow you to increase your hair length in seconds, perfect for fishing bigger baits or snowman style presentations without the need to re-tie your rig.
- Supplied on frames in 3 different lengths (4, 8, 12mm) for maximum versatility.

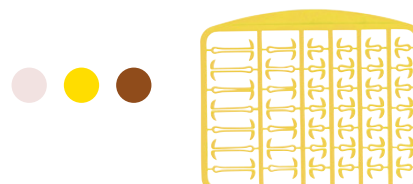

HAIR EXTENDER STOP

- Bait stop available in 3 different lengths to suit to different boilies diameters, without changing the hair length.

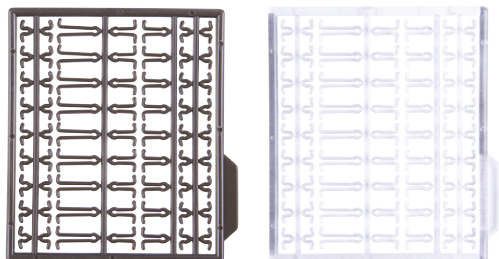

BOILIE STOP CAPS

- These specially shaped Boilie Stop Caps are a discreet and neat alternative to traditional style stops hair stops.



CODE	DIAMETER (MM)	COLOUR	QUANTITY	BARCODE	TRADE PACK
MAGGOT & ULTRA FINE BAIT NEEDLE					
ACS 010267	—	—	—		5
ALL PURPOSE NEEDLE SET					
ACS 010269	—	—	4		5
STICK & STRING NEEDLE SET					
ACS 010270	—	—	2		5
BAIT DRILL					
ACS 010268	1.2	—	—		5
BOILIE DRILL					
871000361	6	—	—		10
BOILIE STOP					
ACS010278	—	Clear	180		5
ACS010279	—	Fluorescent Yellow	180		5
ACS010280	—	Fluorescent Orange	180		5
ACS010281	—	Fluorescent Pink	180		5
ACS010282	—	Fluorescent Red	180		5
ACS010283	—	Brown	180		5
CORN BOILIE STOPS					
ACS010011	—	Yellow	10 + 10		10
BOILIE HAIR EXTENDER					
ACS010290	—	Clear	—		5
ACS010291	—	Fluorescent Yellow	—		5
ACS010295	—	Brown	—		5
HAIR EXTENDER STOP					
ACS010109	—	Black	—		10
ACS010110	—	Clear	—		10
BOILIE STOP CAPS					
926000361	—	Assorted	—		10

STRIP-EAZE TOOL

- Ergonomically designed to fit comfortably between thumb and forefinger.
- The Strip-Eaze Tool has been designed to remove the outer coating safely and easily on combi style hooklinks without damaging the inner braid.

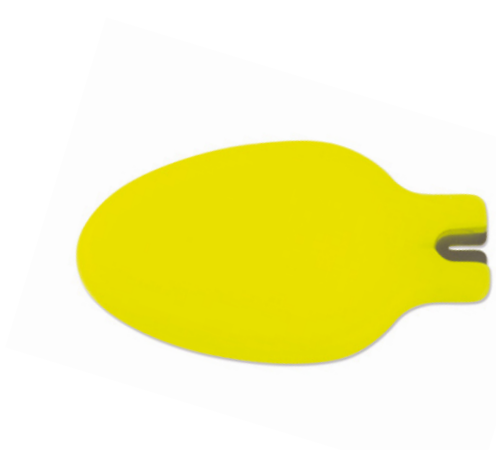
**CUTTING PLIERS**

- These versatile pliers feature spring loaded handles making them easy to use for a multitude of tasks.
- They also feature a precision ground edge perfect for cutting both braid and monofilament line.



CODE	BARCODE	TRADE PACK
STRIP-EAZE TOOL		
ACS010220		5
CUTTING PLIERS		
ACS010118		3



TERMINAL TACKLE, SWIVELS & LEADS

TERMINAL TACKLE

LEAD CLIPS

- | LEAD CLIPS PACK 122
- | LEAD CLIPS 122
- | METALLIC LEAD CLIPS 122
- | LEAD CLIP TAIL RUBBERS 122
- | ANTI-TANGLE LEAD CLIP RIG 122

SLEEVES AND BEADS

- | HELICOPTER SLEEVES AND BEADS 123
- | RUBBER BEADS 123
- | ANTI-TANGLE SLEEVES 123

TUBING & KICKERS

- | SINKING RIG TUBE 124
- | SHRINK TUBE 124
- | SILICONE TUBE 124
- | KICKER – LINE ALIGNER 124
- | KICKER – WITHY POOL 124

ALIGNERS & HOOKLINKS WEIGHTS

- | LINE ALIGNERS 124
- | TUNGSTEN HOOKLINK WEIGHTS 124
- | TUNGSTEN TUBE 125
- | TUNGSTEN PUTTY 125

MAGGOT CLIPS & STOPPERS

- | MAGGOT CLIP 126
- | HOOK RIG STOP 126
- | RIG RING STOP 126
- | ASSORTED BAIT BAND 126

POP-UP PEGS & PINS

- | D-RIG POP-UP PIN 126
- | POP-UP PEGS 126

SWIVELS & RINGS

- | ROLLING SWIVEL 128
- | ROLLING SWIVEL WITH RING 128
- | ROLLING SWIVEL WITH SPEED LINK 128
- | BIG EYE SWIVEL 128
- | QC ROLLING SWIVEL 128
- | QC ROLLING SWIVEL WITH RING 128
- | CORK SCREW SWIVEL 128
- | QUICK LOCK SWIVEL 128
- | PVA BAG SWIVEL 129
- | QUICK CLIP 129
- | LOCK IN SNAP 129
- | OVAL RINGS 129
- | ROUND RINGS 129

LEADS

LEADS

- | LEAD – DISTANCE / SQUARE / UNIVERSAL / TRILOBE / RIVER 130
- | CAMO WEED – DISTANCE / UNIVERSAL 132
- | GRAVEL – DISTANCE / UNIVERSAL / RIVER 133
- | FEATURE FINDING LEAD 134

BACK LEADS

- | BACK LEAD 134
- | BACK LEAD DISCS 134
- | BACK LEAD CLIPS 134

METHOD FEEDER

- | METHOD FEEDER 134

LEAD CLIPS PACK

- Probably the most popular method for attaching a lead with safety in mind.
- The force required to 'ditch' the lead is pre-determined by how far the tail rubber is pushed onto the clip.
- Each clip features a hole to accept the small pin to lock the swivel securely into the body (which is essential for the clip to work properly) but can be removed by using the supplied tool.

Camfusion®

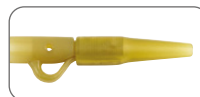

LEAD CLIPS

- Probably the most popular method for attaching a lead with safety in mind.
- The force required to 'ditch' the lead is pre-determined by how far the tail rubber is pushed onto the clip.
- Each clip features a hole to accept the small pin to lock the swivel securely into the body (which is essential for the clip to work properly) but can be removed by using the supplied tool.

Camfusion®



Weed Green



METALLIC LEAD CLIPS

- Ultra-resistant up to 350g for extreme fishing.
- Metal Lead Clips to be used with our rolling N°08.
- Includes: 10 metal lead clips and 10 cones.

Weed Green



LEAD CLIP TAIL RUBBERS

- Designed for to be used in conjunction with our Lead Clips and Rig Tube to create a neat and streamlined connection reducing tangles.

Camfusion®



ANTI-TANGLE LEAD CLIP RIG

- Designed to eliminate tangles during the cast these ready to go rigs incorporate our safety Lead Clips and Sleeves which are fitted to 18" of sinking rig tube.
- Supplied with our QC Swivels as standard.

Camfusion®



Weed Green



HELICOPTER SLEEVES AND BEADS

- Helicopter Bead is made from a slightly harder rubber to provide cushioning and protect the lead link when playing the fish, whilst the softer top bead features a stepped inner bore to ensure that it can pass smoothly over the leader in the event of a breakage.

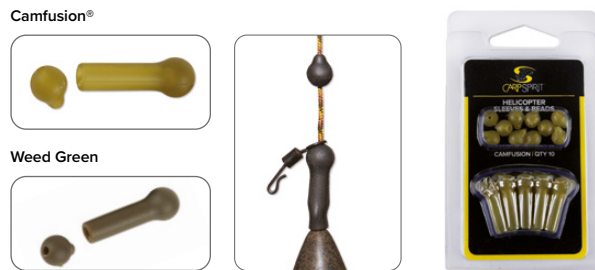

RUBBER BEADS

- These semi soft beads have a multitude of uses and are perfect for protecting knots.
- The stepped internal bore also means they can be used on leadcore or fused leaders for chod and helicopter rigs, yet still pass over the knot in the event of a breakage.



ANTI-TANGLE SLEEVES

- Created for use with our QC swivels, these anti tangle sleeves will not only cover and protect the knot, but also reduce tangles by preventing the hooklink folding back on itself during the cast.



CODE	COLOUR	DIAMETER (MM)	QUANTITY	BARCODE	TRADE PACK
LEAD CLIPS PACK					
ACS010228	Camfusion	—	10		5
LEAD CLIPS					
ACS010360	Camfusion	—	10		5
ACS010361	Weed Green	—	10		5
METALLIC LEAD CLIPS					
ACS010363	Weed Green	—	10		5
LEAD CLIP TAIL RUBBERS					
ACS010231	Camfusion	—	10		5
ANTI-TANGLE LEAD CLIP RIG					
ACS010226	Camfusion	0.30	3		5
ACS010227	Weed Green	0.30	3		5
HELICOPTER SLEEVES AND BEADS					
ACS010232	Camfusion	—	10		5
ACS010249	Weed Green	—	10		5
RUBBER BEADS					
ACS010233	Camfusion	—	25		5
ACS010250	Weed Green	—	25		5
ANTI-TANGLE SLEEVES					
ACS010234 (Std)	Camfusion	—	25		5
ACS010251 (Std)	Weed Green	—	25		5
ACS010235 (Mini)	Camfusion	—	30		5
ACS010252 (Mini)	Weed Green	—	30		5

SINKING RIG TUBE

- Designed to eliminate tangles during the cast, camouflage the line, and also protect the fish from the line during the fight.



SHRINK TUBE

- 3:1 shrink ratio, perfect for covering and protecting hook knots.
- Excellent shrink memory; you can create a range of shaped hook extensions and improve hooking efficiency.

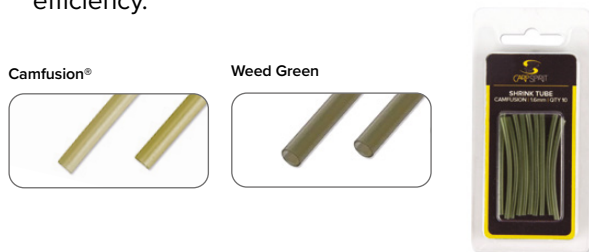

SILICONE TUBE

- Essential for holding the hair securely in place on the hook shank, Silicone Tube will also help reduce tangles and aid hooking efficiency.

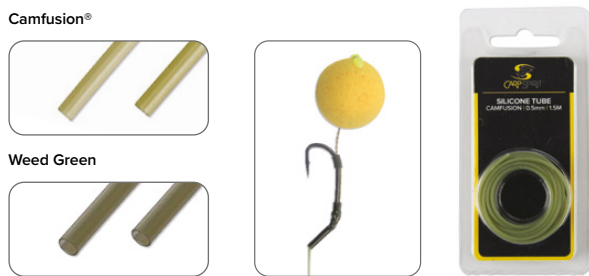

KICKER – LINE ALIGNER

- Designed to create perfect Line Aligner rigs every time without the hassle of shrinking or shaping tube.



KICKER – WITHY POOL

- Designed to create perfect Withy Pool rigs every time without the hassle of shrinking or shaping tube.



LINE ALIGNER

- These pre-formed hook sleeves create the perfect Line Aligner every time.
- By having the hooklink exit the front of the hook, the turning effect and efficiency of the rig is increased.
- A more aggressive hook angle is also created, making the rig harder to eject.

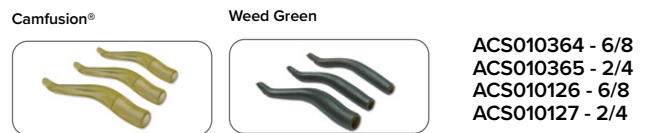

TUNGSTEN HOOKLINK WEIGHTS

- Tungsten Hooklink Weights are perfect pinning down the hooklink to improve rig presentation.



TUNGSTEN TUBE

- Extremely dense rig tube to keep the mainline pinned down tight to the lakebed.
- Length - 2m
- Internal Diameter - 0.6mm
- External Diameter - 1.85mm



TUNGSTEN PUTTY

- High quality Tungsten Putty that can be moulded directly onto hooklinks to counterbalance pop-ups or to make critically balanced baits.
- Top Tip: to make application and shaping easy, simply roll a small piece of putty between the hands to soften.
- Weight - 20g.



CODE	COLOUR	DIAMETER (MM)	LENGTH	QUANTITY	BARCODE	TRADE PACK
SINKING RIG TUBE						
ACS010236	Camfusion	0.7	2m	—		5
ACS010253	Weed Green	0.7	2m	—		5
SHRINK TUBE						
ACS010237	Camfusion	1.2	5cm	10		5
ACS010238	Camfusion	1.6	5cm	10		5
ACS010239	Camfusion	2.4	5cm	10		5
ACS010254	Weed Green	1.2	5cm	10		5
ACS010255	Weed Green	1.6	5cm	10		5
ACS010256	Weed Green	2.4	5cm	10		5
SILICONE TUBE						
ACS010240	Camfusion	0.5	1.5m	—		5
ACS010257	Weed Green	0.5	1.5m	—		5
KICKER – LINE ALIGNER						
ACS010241	Camfusion	—	—	10		5
ACS010258	Weed Green	—	—	10		5
KICKER – WITHY POOL						
ACS010242	Camfusion	—	—	10		5
ACS010259	Weed Green	—	—	10		5
LINE ALIGNER						
ACS010364	Camfusion	—	—	15		10
ACS010365	Camfusion	—	—	15		10
ACS010126	Weed Green	—	—	15		10
ACS010 127	Weed Green	—	—	15		10
TUNGSTEN HOOKLINK WEIGHTS						
ACS010121 (Std)	Khaki	—	—	15		10
ACS010200 (XL)	Khaki	—	—	15		10
ACS010201 (XL)	Brown	—	—	15		10
TUNGSTEN TUBE						
ACS010045	Please see product for specification					10
TUNGSTEN PUTTY						
ACS010051	Dark Green	—	—	—		5
ACS010052	Dark Brown	—	—	—		5

MAGGOT CLIP

- Maggots have long been one of the most effective baits for carp and this bait clip is the perfect solution to fish them on a hair rig.
- Quick and simple to use, simply unclip the point, thread the maggots on and close the clip.



HOOK RIG STOP

- Designed to create various anti-eject, sliding and 360 rigs by easily be sliding onto the hook shank.
- The rubber used is hard enough to stay put on the cast but will move easily when the hook point penetrates the mouth of a fish.
- Use in conjunction with our Pop-Up Pegs to create a very easy but awesome Pop-Up Rig.



Medium

RIG RING STOP

- Rig Ring Stops are silicone beads that can be threaded onto the hook shank either side of a rig ring 'D' to secure it in place, perfect for making 'D' rigs.
- The special shape ensures the ring does not get trapped and is free to move along the hook shank.

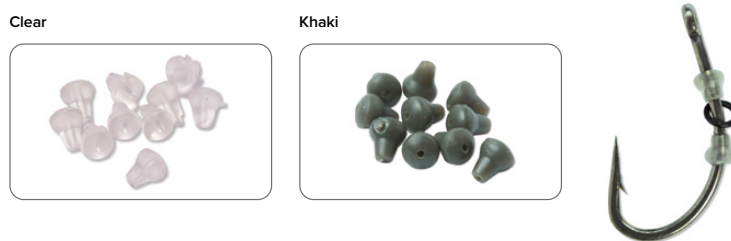

Clear

Khaki

ASSORTED BAIT BAND

- Bait Bands have a variety of uses and are useful to mount hard baits such as pellets and mixers directly onto the hook shank or for making 'D' rigs.



D-RIG POP-UP PIN









- These stainless-steel pins are perfect for making 'D' Rigs.
- Simply insert the pin into the boilie, the barb will ensure the bait stays on even during long casts and the ring can be secured on the hook shank with a rig stop either side.
- Recommended for hard or air-dried baits.



POP-UP PEGS

- Quick and simple to use, simply screw on your pop-up.
- The base ensures water does not penetrate the pop up and prevent the bait from swelling up over the ring.
- The screw thread provides exceptional grip to ensure the bait does not come off during the cast.



CODE	COLOUR	QUANTITY	BARCODE	TRADE PACK
MAGGOT CLIP				
ACS010152	—	20		10
HOOK RIG STOP				
ACS010297	—	50		5
RIG RING STOP				
ACS010056	Clear	10		10
ACS010177	Khaki	10		10
ASSORTED BAIT BANDS				
ACS010101	Clear & Brown	45		10
D-RIG POP-UP PIN				
ACS010153	—	20		10
POP-UP PEGS				
ACS010284	Clear	20		5
ACS010285	Fluorescent Yellow	20		5



ROLLING SWIVEL

- Available in a range of sizes, they are perfectly formed and have a dull, non-reflective, matt-black finish to prevent spooking the fish.



No. 8



No. 11

ROLLING SWIVEL WITH RING

- Originally designed for creating the highest degree of flexibility between your mainline and hook link, they are incredibly versatile, allowing you to create a multitude of bottom, pop-up and zig rigs.



No. 8



No. 11

ROLLING SWIVEL WITH SPEED LINK

- High quality swivels with a pre fitted speed link for quick change of terminal tackle and hooklinks.
- Perfectly formed featuring a dull, non-reflective, matt-black finish to prevent spooking the fish.



BIG EYE SWIVEL

- Big Eye Swivels feature a larger eye to ensure your hook link revolves freely around your leadcore or rig tubing.
- These are the perfect swivels to use for creating helicopter rigs, or for making resistance-free running rigs, or even for marker float set-ups.



QC ROLLING SWIVEL

- QC Swivels are designed for a quick change of hook links without having to cut line and re-tie knots.
- Perfect when fishing with PVA sticks, when the hook link needs to be drawn through the stick and then clipped on to the swivel, simply slide over a tail rubber to keep everything neat.



QC ROLLING SWIVEL WITH RING

- Instantly replace a hook link or lead without having to re-tie rigs, these swivels also feature an additional ring that makes them incredibly flexible.
- Perfect swivels to use when fishing hinged stiff rigs.



CORK SCREW SWIVEL

- Corkscrew Swivels are fast and simple to use.
- Looped hooklinks can be attached and removed quickly and effortlessly, ideal for PVA Sticks and PVA bags where the hooklink needs to be removed.



QUICK LOCK SWIVEL

- Quick Lock Swivels are quick and easy to use.
- Looped hooklinks can be attached and removed quickly and effortlessly, ideal for PVA sticks and PVA bags where the hooklink needs to be removed.



PVA BAG SWIVEL

- The special shape loop makes these swivels the quickest and easiest way to attach a PVA-mesh bag to your setup. Simply pass the knot of your PVA mesh bag through the large loop and pull down between the slim gap to secure into place.



LOCK IN SNAP

- Lock In Snaps have a multitude of uses and are ideal for quick change of many terminal tackle parts and rigs.



QUICK CLIP

- Quick Clips have a multitude of uses and are ideal for quick change of many terminal tackle parts and rigs.



SPINNER SWIVELS

- A quick change purposely designed swivel to create the Spinner rig/Ronnie rig.
- Use a small piece of shrink tube to cover the connection and to keep the hook at the correct angle.
- Each swivel has a dull, non-glare, matt black finish to prevent the fish being spooked.



RINGS

- **Oval Rings** are perfect for making combi style rigs and joining different materials together such as fluorocarbon and braid.
- **Round Rings** are perfect for creating 'D' rigs or 360 style rigs by threading onto the hook shank and securing in place with our hook rig stops.
- Available in 2 sizes: 3.5mm and 3.7mm.



CODE	SIZE NO.	DIAMETER (MM)	SHAPE	QUANTITY	BARCODE	TRADE PACK
ROLLING SWIVEL						
ACS290003	11	—	—	10		10
ACS290004	08	—	—	10		10
ACS290005	08	—	—	20		10
ROLLING SWIVEL WITH RING						
ACS290006	11	—	—	10		10
ACS290007	08	—	—	10		10
ROLLING SWIVEL WITH SPEED LINK						
ACS290013	—	—	—	10		10
BIG EYE SWIVEL						
ACS290001	08	—	—	10		10
QC ROLLING SWIVEL						
ACS290011	08	—	—	10		10
QC ROLLING SWIVEL WITH RING						
ACS290012	08	—	—	10		10
CORK SCREW SWIVEL						
ACS290020	—	—	—	10		10
QUICK LOCK SWIVEL						
ACS290002	—	—	—	5		10
PVA BAG SWIVEL						
ACS290000	—	—	—	10		10
QUICK CLIP						
ACS290008	—	—	—	10		10
LOCK IN SNAP						
ACS290009	—	—	—	10		10
SPINNER SWIVELS						
ACS290021	11	—	—	10		10
ACS290022	11 + Ring	—	—	10		10
RINGS						
ACS290016	—	4.5	Oval	10		10
ACS290014	—	3.5	Round	10		10
ACS290015	—	3.7	Round	10		10

DISTANCE

- These torpedo shaped leads are ideal for long range casting and provide extreme accuracy to.
- Coated with impact resistant rubber and pad printed to easily identify the weight.



TRILOBE

- Excellent for distance, the special flat sides and groves help prevent rolling off and will help rapid rising to the surface during retrieval.
- Coated with impact resistant rubber and pad printed to easily identify the weight.



SQUARE

- These square shaped leads are great for casting, but due to their flat sides will not roll off on sloping gravel bars; the compact shape also provides excellent hooking.
- Coated with impact resistant rubber and pad printed to easily identify the weight.



UNIVERSAL

































- Perfect for use in both lakes and rivers, the large flat sides will help the lead hold the bottom and prevent rolling off on sloping gravel bars.
- Coated with impact resistant rubber and pad printed to easily identify the weight.



RIVER

- The flat hollow disc shape with raised bumps on both sides creates maximum surface area for holding bottom, perfect for fishing.
- Coated with impact resistant rubber and pad printed to easily identify the weight.



CODE	QUANTITY	WEIGHT (G)	WEIGHT (OZ)	BARCODE
DISTANCE				
ACS550098	x12	40	1.40	
ACS550030	x12	50	1.80	
115960361	x12	60	2.10	
257070361	x12	70	2.45	
ACS550032	x12	80	2.80	
258090361	x12	90	3.15	
259100361	x12	100	3.50	
260110361	x12	110	3.90	
261130361	x12	130	4.60	
262150361	x12	150	5.30	
SQUARE				
ACS550027	x12	50	1.80	
ACS550028	x12	70	2.45	
ACS550022	x12	84	2.95	
ACS550023	x12	112	3.95	
UNIVERSAL				
275070361	x12	70	2.45	
276090361	x12	90	3.15	
277100361	x12	100	3.50	
278110361	x12	110	3.90	
279120361	x12	120	4.25	
TRILOBE				
ACS550034	x12	50	1.80	
116060361	x12	60	2.10	
269070361	x12	70	2.45	
ACS550036	x12	80	2.80	
270090361	x12	90	3.15	
271100361	x12	100	3.50	
272110361	x12	110	3.90	
273130361	x12	130	4.60	
RIVER				
264100361	x12	100	3.50	
265120361	x12	120	4.25	
266140361	x12	140	4.95	
267160361	x12	160	5.65	
268200361	x12	200	7.05	
117925361	x12	250	8.80	

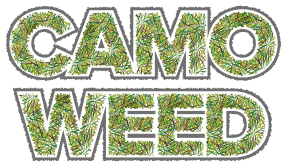

Camo Weed leads offer the ultimate in end tackle camouflage. Each lead is put through a special process to impregnate the surface with thousands of tiny weed green bristles. Camo Weed coating is tough and durable but also short enough to avoid hooklinks tangling in the bristles.

CAMO WEED DISTANCE

- Shape allowing to reach the maximum distances.



CAMO WEED UNIVERSAL

- Universal shape adapted to different fishing conditions.



CODE	QUANTITY	WEIGHT (G)	WEIGHT (OZ)	BARCODE	TRADE PACK
CAMO WEED DISTANCE					
ACS550148	Bulk	70	2.45		12
ACS550149	Bulk	90	3.15		12
ACS550150	Bulk	110	3.90		12
CAMO WEED UNIVERSAL					
ACS550152	Bulk	70	2.45		12
ACS550153	Bulk	90	3.15		12
ACS550154	Bulk	100	3.50		12



GRAVEL LEADS

End tackle camouflage and presentation at its best. Gravel coated leads are put through a multi-stage dipping process to create a durable, non-reflective and textured effect to the lead surface, making them ideal for fishing on clear spots, gravel bars, or in clear water.

GRAVEL DISTANCE

- Shape allowing to reach the maximum distances.



GRAVEL RIVER

- Design particularly recommended for river fishing.



GRAVEL UNIVERSAL

- Universal shape adapted to different fishing conditions.



CODE	QUANTITY	WEIGHT (G)	WEIGHT (OZ)	BARCODE	TRADE PACK
GRAVEL DISTANCE					
ACS550007	Bulk	85	2.95		12
ACS550008	Bulk	100	3.50		12
ACS550009	Bulk	115	3.95		12
GRAVEL RIVER					
ACS550003	Bulk	115	3.95		12
ACS550004	Bulk	140	4.95		12
ACS550005	Bulk	170	6.00		12
ACS550006	Bulk	230	8.11		12
GRAVEL UNIVERSAL					
ACS550011	Bulk	70	2.45		12
ACS550012	Bulk	85	2.95		12
ACS550013	Bulk	100	3.50		12
ACS550015	Bulk	140	4.95		12



FEATURE FINDING LEAD

- These specialist leads feature four 'probes' which when dragged back along the bottom help to transmit feeling and vibration through the rod tip.



BACK LEAD

- Flat based and cone shaped, these Back Leads are perfect for sinking your mainline under the rod tip. Supplied with a low friction clip.



BACK LEAD CLIPS

- Perfect for use with our Back Lead Discs.
- Simply hook onto the Back Lead Disc and slide the sleeve over.
- The large loop then be clipped onto the mainline to sink your mainline under the rod tips.



METHOD FEEDER

- High quality moulded Method Feeder.
- The 3-fin design features a weight on one side only so that the hook bait can be positioned on the opposite side to ensure the bait is presented perfectly every time.



CODE	WEIGHT (G)	WEIGHT (OZ)	QUANTITY	BARCODE	TRADE PACK
FEATURE FINDING LEAD					
ACS550101	112	4	1		3
ACS550102	140	5	1		3
BACK LEAD					
ACS550000	20	0.70	1		10
ACS550021	40	1.40	1		10
BACK LEAD CLIPS					
ACS010130	—	—	5		10
METHOD FEEDER					
130040360	40	1.40	1		10

PVA & PROTECTION MESH

SOLURON

- | PVA TUBE 136
- | PVA 3 IN 1 TUBE 136
- | PVA TUBE REFILL 136
- | PVA STRING 136
- | PVA TAPE 136
- | PVA BAGS 138
- | PVA BAGS & STRING 138
- | PVA LOADER STARTER PACK 138
- | LOADER BAGS 138
- | PVA BAG FUNNEL LOADER 138

PROTECTION MESH

- | TUBE 140

CAT & CRAYFISH

- | SHRINK WRAP BOILIE GUARD 140
- | NET PROTECTION 140



PVA TUBE

- The tube features a tight, anti-ladder mesh construction and the flared funnel loader makes loading of bait quick and simple with reduced spillages.
- Soluron PVA tube is perfect for stick mixes, chopped boilies, ground bait, maggots and more.
- Once empty, tube re-filler spools can be purchased separately.
- 10m PVA tube on a pre-loaded flared funnel.
- 1x plunger included, 1x sealed storage tube.
- Breakdown time approx. 2 minutes in water at 20°C.
- Available in three sizes: 30mm, 22mm and 14mm.



PVA 3 IN 1 TUBE

- Soluron PVA tube '3 in 1' is a complete PVA pack with 3 diameters of tube.
- Made using only the highest quality PVA, the tube itself features a tight, anti-ladder mesh construction and the flared funnel loaders make loading of bait quick and simple with reduced spillages.
- Soluron PVA tube is perfect for stick mixes, chopped boilies, ground bait, maggots and more.
- The funnels stack neatly inside each other for safe storage in the sealed storage tube.
- Once empty, tube re-filler spools can be purchased separately.
- 3x 10m PVA tubes on 3x pre-loaded flared funnels.
- 2x plungers, 1x sealed storage tube.
- Breakdown time approx. 2 minutes in water at 20°C.
- All three sizes included: 30mm, 22mm and 14mm.



PVA TUBE REFILL

- Soluron PVA tube refill spools are perfect for anglers who already have Soluron plungers and funnels.
- Breakdown time approx. 2 minutes in water at 20°C
- Refill spools are available in 5m and 10m in the following sizes: 30mm, 22mm and 14mm.



PVA STRING















- Soluron PVA String is incredibly versatile.
- Perfect for tying off PVA Bags, stringing boilies or even tying back rigs for distance casting.
- Available in Four versions:
 - 151500361 - 1 Strand
 - 151600361 - 2 Strand
 - 151700361 - 4 Strand
 - 022600211 - Multi-Strand



PVA TAPE

- Soluron PVA Tape is perfect for threading on boilies.
- Made using only the highest quality PVA, the flat profile of the tape provides friction when threading the boilies on with a stringer needle.
- This allows the baits to be spaced apart and prevent them closing together during the cast.



CODE	LENGTH (M)	DIAMETER (MM)	SIZE	QUANTITY	BARCODE	TRADE PACK
PVA TUBE						
ACS010012	10	14	—	1		5
151900361	10	22	—	1		5
152000361	10	30	—	1		5
PVA 3 IN 1 TUBE						
ACS010014	10	14, 22 & 30	—	1		3
PVA TUBE REFILL						
ACS010058	5	14	—	1		5
ACS010059	5	22	—	1		5
ACS010060	5	30	—	1		5
ACS010013	10	14	—	1		5
152100361	10	22	—	1		5
152200361	10	30	—	1		5
PVA STRING						
151500361	20	—	L	1		5
151600361	20	—	XL	1		5
151700361	20	—	XXL	1		5
022600211	50	—	—	1		5
PVA TAPE						
151800361	20	10	—	1		5



PVA BAGS

- Manufactured from high quality film, ensuring the bag is sturdy and unlikely to rip or split.
- Dissolves in about 2 minutes in water at 20°C.
- To be used with boilies, seeds or pellets.

**PVA LOADER STARTER PACK**

- 2 sizes of loader, and closing rings supplied.
- Matching PVA bags included.
- Perfect fit and easy loading every time.
- Spare Bags to match available: Size 1 x 10 and Size 2 x 10.

**PVA BAGS & STRING**

- Manufactured from high quality film, ensuring the bag is sturdy and unlikely to rip or split.
- Dissolves in about 2 minutes in water at 20°C.
- To be used with boilies, seeds or pellets.

**LOADER BAGS**

- Spare Bags to match with the PVA Loader.

**PVA BAG FUNNEL LOADER**

- This funnel loader makes the task of loading up PVA bags quick and simple with a large open top to reduce spillage.
- It features a full length slit down the side so that the hooklink can easily be removed after loading.
- Hi-Viz Yellow colour.





CODE	LENGTH (MM)	WIDTH (MM)	SIZE	QUANTITY	BARCODE	TRADE PACK
PVA BAGS						
152300361	100	70	L	10		5
152400361	125	100	XL	10		5
152500361	200	70	XXL	10		5
ACS010374	100	70	L	25		5
ACS010375	125	100	XL	25		5
ACS010376	200	70	XXL	25		5
PVA BAGS & STRING						
152600361	100	70	L	10		5
152700361	125	100	XL	10		5
152800361	200	70	XXL	10		5
PVA LOADER STARTER PACK						
ACS010215	—	—	M+L Shovel	20		5
LOADER BAGS						
ACS010216	—	—	1	20		5
ACS010217	—	—	2	20		5
PVA BAG FUNNEL LOADER						
ACS010159	—	—	—	—		3

TUBE

- Protection Mesh is a super strong fine mesh that does not dissolve.
- This allows you to fish a huge range of baits that have been previously difficult to use on a hair rig such as hemp, corn, crushed boilies, maggots, and other small size baits.
- The strong mesh construction still allows the colour and the flavour of the bait to pass through.
- It also offers added protection from Cray and Catfish.
- Once empty, re-fill spoils can be purchased separately.
- 7M Protection Mesh on a pre-loaded flared funnel.
- Plunger included.
- Sealed Storage tube.
- Available in two sizes: 22mm and 14mm.



CAT & CRAYFISH SHRINK WRAP BOILIE GUARD

- Simply place a piece of protector over the boilie and then shrink down tight using kettle steam.
- The premade holes still allow the flavour to leak out from the hookbait.
- Available in 2 sizes: 15/20mm and 20/25mm.



CAT & CRAYFISH NET PROTECTION

- Simply place a piece of protector over the boilie and then shrink down tight using kettle steam.
- The premade holes still allow the flavour to leak out from the hookbait.
- Available in 2 sizes: 15/20mm and 20/25mm.



CODE	LENGTH (M)	DIAMETER (MM)	DIMENSIONS (CM)	QUANTITY	BARCODE	TRADE PACK
PROTECTION MESH TUBE						
ACS010368	7	14	—	—		5
ACS010369	7	22	—	—		5
CAT & CRAYFISH SHRINK WRAP BOILIE GUARD						
845000361	—	15 & 20	—	10		10
846000361	—	20 & 25	—	10		10
CAT & CRAYFISH NET PROTECTION						
844000361	—	—	50 x 40	1		5

BAITING UP

THROWING STICKS

- | BLAX™ CARBON THROWING STICK 142
- | PVC THROWING STICK 142

BAIT CRUSHERS

- | METAL BAIT CRUSHER 142

BAIT SHOVELS & HANDLES

- | BAITING SCOOP HANDLE 142
- | BAIT SCOOP HEAD 142
- | ONE PIECE SCOOP 142
- | BAITING SHOVEL 142

MARKERS

- | A.L.S MARKER 143
- | STATIC MARKER 143
- | DISCOVERY MARKER FLOAT 143

BAIT STORAGE

- | BUCKET 144
- | TRIPOD BUCKET STAND 144
- | FOLDABLE BUCKET 144
- | BOILIE BAG 144
- | SET OF 4 POP-UP/DIP POTS 144

BOILIE GUNS & ROLLING TABLES

- | BOILIE ROLLING TABLE 144
- | PNEUMATIC ALUMINIUM BAIT GUN 145
- | MANUAL ALUMINIUM BAIT GUN 145
- | BAIT GUN NOZZLE 145



BLAX CARBON THROWING STICK

- Made from lightweight carbon fibre.
- Suitable for boilies up to 20mm.
- Reinforced tip for increased strength.
- Tip: Dip the end of the stick in water if using soft baits to reduce splitting on exit.



PVC THROWING STICK

- PVC Throwing Sticks are lightweight, strong, and durable.
- Each stick features the same specially developed 'J curve' which has been optimised to accelerate and increase boilie speed, aiding accuracy and distance.



METALLIC BAIT CRUSHER

- This version of the Bait Crusher features reinforced metal teeth, which will make light work of even hard baits such as nuts and seeds.



BAITING SCOOP HANDLE

- Made from ultra-strong fibreglass featuring dual grips, simply attach a baiting scoop to the threaded end.
- Sold without shovel.



BAIT SCOOP HEAD

- Made from ultra-strong moulded ABS, simply attach the scoop to a baiting handle using the thread.
- Sold without a handle.



ONE PIECE SCOOP

- Made from ultra-strong moulded ABS this simple and economical one-piece scoop is perfect for baiting up from the boat.



BAITING SHOVEL

- Lightweight baiting shovel with carbon sleeve.
- Screwed-head for space-saving.
- Reinforced handle EVA.



A.L.S MARKER

- Water sensors and Light Dependant Resistors (LDR's) work together so that the Hi-Viz red LEDs will automatically turn on only when the marker is placed in water and when it's dark.
- Accepts 2x AA Batteries.
- Up to 100 hours run time.

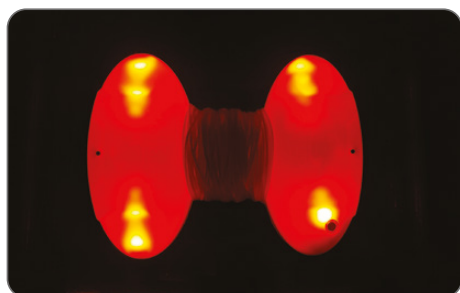

DISCOVERY MARKER FLOAT

- Featuring high visibility interchangeable flights, these extremely buoyant marker floats are sold in pairs.
- Both floats are fitted with popular orange vanes and included are yellow and black flights for varying light conditions.
- Manufactured from high impact resistant plastic with the swivel moulded into the bottom to ensure it never pulls out.



STATIC MARKER

- Made from a high buoyancy and Hi -Viz material, simply clip a large weight onto the snap link and drop over the edge of the boat to mark a spot.



CODE	WEIGHT (G / KG)	FOR BAITS UP TO (MM)	LENGTH (CM)	COLOUR	BARCODE	TRADE PACK
BLAX™ CARBON THROWING STICK						
ACS010380	70g	20	—	—		1
PVC THROWING STICK						
ACS010298	—	18	—	—		1
METAL BAIT CRUSHER						
151400361	0.61 kg	—	12.3	Black		1
BAITING SCOOP HANDLE						
697003360	—	—	35	Black		1
BAIT SCOOP HEAD						
695001360	—	—	—	Black		1
ONE PIECE SCOOP						
ACS010160	—	—	—	Black		5
BAITING SHOVEL						
ACS010161	—	—	—	—		1
A.L.S MARKER						
ACS010385	—	—	—	Orange		1
STATIC MARKER						
ACS010382	—	—	—	Orange		3
DISCOVERY MARKER FLOAT						
ACS010301	—	—	—	—		5

BUCKET

- High quality moulded bait bucket, perfect for transporting boilies, seeds, and pellets in both wet and dry states.
- 18 litre capacity.



FOLDABLE BUCKET

- Very practical bucket in waterproof PVC.
- Foldable for space saving.



TRIPOD BUCKET STAND

- Fully adjustable height from 0.9 to 1.3 meters.
- Removable legs.
- Lightweight Aluminium.
- Sold without bucket.
- Weight - 1.75kg.



BOILIE BAG

- Transport and drying bag.
- Anti-mould rubber meshes.



SET OF 4 POP-UP/DIP POTS

- Perfect for storing Pop-Ups and liquid soaked hook baits.
- The lid features an integrated 'O' ring to create a tight seal and prevent liquid escaping during transportation.



BUCKET AND COVER

- High quality moulded bait bucket, perfect for transporting boilies, seeds, and pellets in both wet and dry states.
- 100% waterproof closing lid.
- 13.2 litre capacity.
- Transparent window.
- Level gauge.



BOILIE ROLLING TABLE

- Non-slip base.
- For making baits in sizes 14, 16, 18 and 20mm.



MANUAL ALUMINIUM BAIT GUN

- Features a 0.7l tube for injecting bait.
- Strong & lightweight aluminium cylinder construction.
- Supplied with nozzle that can be cut to any desired size – additional nozzles sold separately.



BAIT GUN NOZZLE

- Graduated nozzle to ease the cutting to the desired diameter.



PNEUMATIC ALUMINIUM BAIT GUN

- Strong & lightweight aluminium cylinder construction.
- Adjustable pressure valve.
- Supplied with nozzle that can be cut to any desired size – additional nozzles sold separately.
- Capacity 0.75L.
- Maximum input pressure 145psi.



CODE	CAPACITY (L)	DIAMETER (MM)	DIMENSIONS (CM)	BARCODE	TRADE PACK
BUCKET					
ACS010372	18	—	—		1
TRIPOD BUCKET STAND					
ACS010373	—	32.5	—		1
BUCKET AND COVER					
020210362	13.2	—	—		1
FOLDABLE BUCKET					
ACS140008	6	—	—		1
BOILIE BAG					
984000361	—	—	34(W) x 44(H)		1
SET OF 4 POP-UP/DIP POTS					
ACS140006	—	—	—		5
BOILIE ROLLING TABLE					
938000361	—	14	—		1
939000361	—	16	—		1
940000361	—	18	—		1
941000361	—	20	—		1
MANUAL ALUMINIUM BAIT GUN					
944000361	0.7	—	—		1
BAIT GUN NOZZLE					
946000361	—	—	—		5
PNEUMATIC ALUMINIUM BAIT GUN					
945000361	0.6	—	—		1

CLOTHING

T-SHIRTS

| GREEN T-SHIRT 147

| CHARCOAL T-SHIRT 147

HOODIES

| GREEN HOODIE 147

| CHARCOAL HOODIE 147

JOGGERS 148

HATS

| CAPS 148

| BEANIE 148



T-SHIRT

- Lightweight & cool
- Green T-shirt - 100% Cotton.
- Charcoal T-shirt - 60% Polyester/40% Cotton. 180gs T-Shirt.
- Printed front logo (Green & Charcoal).
Printed back logo (Green Only).
- Woven sleeve logo.
- Available in sizes S/M/L/XL/XXL.



HOODIE

- 60% Polyester/40% Cotton.
- 280gsm.
- Printed front logo (Green & Charcoal).
- Printed back logo (Green Only).
- Fully lined hood with drawstring adjustment.
- Moulded rubber sleeve badge.
- Elasticated waist & cuffs.
- Generous length to reduce 'rising up' whilst casting.
- Available in sizes S/M/L/XL/XXL.



CODE	COLOUR	SIZE	BARCODE	TRADE PACK
T-SHIRTS				
ACS680085	Green	S		1
ACS680072	Green	M		1
ACS680073	Green	L		1
ACS680074	Green	XL		1
ACS680086	Green	XXL		1
ACS680081	Charcoal	S		1
ACS680066	Charcoal	M		1
ACS680067	Charcoal	L		1
ACS680068	Charcoal	XL		1
ACS680082	Charcoal	XXL		1
HOODIES				
ACS680087	Green	S		1
ACS680075	Green	M		1
ACS680076	Green	L		1
ACS680077	Green	XL		1
ACS680088	Green	XXL		1
ACS680083	Charcoal	S		1
ACS680069	Charcoal	M		1
ACS680070	Charcoal	L		1
ACS680071	Charcoal	XL		1
ACS680084	Charcoal	XXL		1

JOGGERS

- 60% Polyester/40% Cotton.
- 280gsm.
- 2x zipped front pockets.
- 1x zipped rear pocket.
- Elasticated waist with drawstring adjustment. Elasticated ankles.
- Embroidered logo on rear pocket. Moulded rubber logo on leg.
- Available in sizes S/M/L/XL/XXL.



HATS

- Extensive range of hats to suit all tastes and styles.
- Beanie included in range for colder months.



ACS680058



ACS680060



ACS680061



ACS680062



ACS680063



ACS680064



ACS680065

CODE	DESCRIPTION	COLOUR	SIZE	BARCODE	TRADE PACK
JOGGERS					
ACS680089	Joggers	Green	S		1
ACS680078	Joggers	Green	M		1
ACS680079	Joggers	Green	L		1
ACS680080	Joggers	Green	XL		1
ACS680090	Joggers	Green	XXL		1
HATS					
ACS680060	Flat Peak – CS Trilobe Logo	Black	One Size		1
ACS680061	Flat Peak – 3D Logo	Green	One Size		1
ACS680062	Baseball – CS Trilobe Logo	Green	One Size		1
ACS680063	Baseball – 3D Logo	Green	One Size		1
ACS680064	Baseball – CS Deluxe	Black	One Size		1
ACS680065	Beannie Hat – CS Trilobe Logo	Green	One Size		1
ACS680058	Baseball	Black	One Size		1

ACCESSORIES

LIGHTING

BIVVY LIGHTING

| REMOTE LED BIVVY LIGHT **150**

IMITATION BAITS

IMITATION BAITS

| FLURO FLOATING CORN **150**

TACKLE BOXES

| SINGLE TERMINAL TACKLE BOX **150**

| TACKLE BOX SET **151**



REMOTE LED BIVVY LIGHT

- 21cm design – for wide light beam.
- 5 light modes:
 - Bright white (up to 8 hours)
 - Power save white (up to 60 hours)
 - Bright red
 - Power save red
 - Red S.O.S.
- USB power bank function- Li-ion 3.7V-2000mAH. Double folded hanging loops.
- Can be used with Bivvy magnet clips.
- Power level indicator.
- Full function remote control – up to 15m range. USB lead and lanyard included.

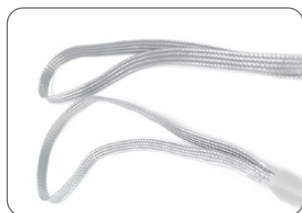

FLURO FLOATING CORN

- Floating imitation corn can be used either on its own or with real baits.
- Can also be soaked in liquid flavours for enhanced attraction.



FAST ROD POD

- One of the easiest and fastest rod pods to set up.
- Lightweight – made with aluminium.
- Foldable and telescopic legs.
- Carry bag included.
- Extendable from 85cm to 125cm.
- Maximum height 85cm.



SINGLE / DOUBLE TERMINAL TACKLE BOX

- Rigid box to store terminal tackles.
- Tinted cover.



TACKLE BOX SET

- Tackle box to store all your accessories, braids, terminal tackle and is composed of:
 - x1 – large main tackle box with adjustable dividers.
 - x1 – rig storage box with foam inserts and pins x1.
 - x1 – small 2 section box.
 - x2 – small 3 section box.
 - x2 – small 4 section box.
- Tinted cover to protect your accessories from the sun.



x1 – small 2 section box

x2 – small 3 section boxes



x2 – small 4 section boxes



Large main tackle box with adjustable dividers x1

CODE	COLOUR	DIMENSIONS (CM) LxWxD	QUANTITY	BARCODE	TRADE PACK
REMOTE LED BIVVY LIGHT					
ACS380010	—	—	—		1
FLURO FLOATING CORN					
ACS010094	Red	—	10		10
ACS010095	Pink	—	10		10
ACS010096	Yellow	—	10		10
ACS010099	Assorted	—	10		10
FAST ROD POD					
ACS370007	—	—	—		1
SINGLE / DOUBLE TERMINAL TACKLE BOX					
ACS140005 (S)	—	34 x 9.5 x 2.5	—		1
126000360 (D)	—	34 x 9.5 x 4.5	—		1
TACKLE BOX SET					
ACS140002	—	36 x 30	—		1

POINT OF SALE

DISPLAY STANDS

| METAL DISPLAY STAND 153

| CS ROD STAND 153

DISPLAY BOARDS

| GENERIC HOOKLINK BOARD 153



METAL DISPLAY STAND

- 60 Black Varnished Metallic pegs 10cm.
- 60 Black Varnished Metallic pegs 15cm.
- LED light on top with 220 V plug.
Contact sales team for more information.



CODE	DIMENSIONS (CM)	WEIGHT (KG)
ACS010343	100(w) x 50(d) x 63(h)	—

CARP SPIRIT ROD STAND

- Holds 20 rods.
- Double sided panel: Magnum and BLAX.



CODE	DIMENSIONS (CM)	WEIGHT (KG)
ACS990007	64(w) x 114(h)	—

GENERIC HOOKLINK BOARD

- Supplied empty. Will hold 24x small hooklinks or x16 large hooklinks, or a mixture of both.



CODE	DIMENSIONS (CM)	WEIGHT (KG)
ACS010340	47(w) x 63(h)	—



INDEX

4D™ Braid 108

A

A.L.S Marker 143

ACCESSORIES 149

ACCESSORY BAGS 24

Adjustable Hangers 50

ALARMS 42

ALARMS & INDICATORS 41

All Purpose Needle Set 118

Anti-Tangle Lead Clip Rig 122

Anti-Tangle Sleeves 123

Assorted Bait Band 126

B

Back Lead 134

Back Lead Clips 134

Bag & Large Boxes 23

Bait Bag 23

Bait Drill 118

Bait Floss™ 114

Bait Gun Nozzle 145

Bait Scoop Head 142

BAIT SHOVELS & HANDLES 142

BAITING NEEDLES, BAIT

DRILLS & HAIR STOPS 117

Baiting Scoop Handle 142

Baiting Shovel 142

BAITING UP 141

Bankstick & Buzz Bar Bag 24

BANKWARE & PODS 51

BARROWS 26

Bed Chair Table 7

BEDS 4

BEDS & CHAIRS 3

Big Eye Swivel 128

BITE ALARMS 42

BITE INDICATORS 50

BIVVIES & SHELTERS 27

BIVVIES 28

BIVVY & OVERNIGHT ACCESSORIES 39

BIVVY LIGHTING 150

Bivvy Table 40

Black Boat 240wi 92

Black Boat 270wi 92

Black Boat 300wi 93

Black Boat 320w 93

Black Boat One 180 89

Black Boat One 230 89

BLAX 1 Man 30

BLAX 2 Man 30

BLAX 3 Season 14

BLAX Alarm 44

BLAX Alu-lite Pod Base 62

BLAX Bankware 52

BLAX Bed 6

BLAX Carbon Throwing Stick 142

BLAX Low Chair 8

BLAX Marker Rod 69

BLAX Razorback Brolly **NEW** 37

BLAX Razorlite Bivvy **NEW** 31

BLAX Rod Pod 63

BLAX RODS 68

BLAX Spod Rod 69

BLAX Storm Poles 39

BLAX Twin Thread Buzz Bars 62

BLAX VX-R Alarm 45

BLAX X-Net **NEW** 76

BLAX X-Pod System **NEW** 63

BOAT ACCESSORIES 94

BOATS 85

Boilie Drill 118

Boilie Hair Extend 118

Boilie Rolling Table 144

Boilie Stop 118

Boilie Stop Cap 119

Boilie Bag 144

Braid & Hard Bait Needle 117

BRAIDED MAINLINE 108

Bucket 144

C

Camfusion Leader 112

CAMO WEED – Distance / Universal 132

Camping Set 25

Camping Set Deluxe 25

Caps 148

CARP CARE & WEIGHING 80

CARP CRADLES 81

CARRYALLS 22

Casting Glove – Right Hand 110

CAT & CRAYFISH 140

Celt-2X™ 106

Chain Hanger	50	Hoodies	147
CHAIRS	8	Hook Rig Stop	126
CLOTHING	146	HOOKLINKS	113
Combi-Soft™	114	HOOCS	99
Combi-Stiff™	114	HOOCS & READY RIGS	97
Cord 15m	40	Hydro Luggage	24
Corn Boilie Stops	118		
Cutting Pliers	120		
D		I	
Deluxe Dial Scale 54kg	84	INOX Bankware	56
Deluxe Weigh Sling	83	INOX Rod Pod	64
Dial Scale 54kg	84		
Digital Scale 50kg	84	J	
Discovery Marker Float	143	Joggers	148
Dressen-X™	109		
D-Rig Pop-Up Pin	126	K	
D-Spool Stripper	110	Kameleon	114
		Kicker – Line Aligner	124
		Kicker – Worthy Pool	124
E		L	
Enduro Case	25	Landing Net Accessories	79
Everest 1 Man	34	LANDING NETS	75
		LEAD – Distance / Square /	
		Universal / Trilobe / River	130
		Lead Case	25
		Lead Clip Tail Rubbers	122
		LEAD CLIPS	122
		Lead Clips Pack	122
		LEADERS	112
		LEADS	130
		LIGHTING	150
		Line Aligners	124
		LINE REMOVER	110
		Lock in Snap	129
		LUGGAGE	19
		LUGGAGE & TRANSPORT	18
		M	
		Maggot & Ultra Fine Bait Needle	118
		Maggot Clip	126
		Magnum 100 Bivvy NEW	33
		Magnum 13ft Rod Holdall	19
		Magnum 4 Season	15
F			
Fast Rod Pod	150		
Feature Finding Lead	134		
Fine Lip Close Needle	117		
Fluoro Leader	112		
Fluro Floating Corn	150		
Foldable Bucket	144		
G			
GRAVEL – Distance / Universal / River	133		
Gravity™ LFL	111		
Gravity™ Spliced Leadcore Leaders	112		
Gravity™ UHL	111		
H			
Hair Extender Stop	119		
Half Moon Pillow	17		
HD2	46		
HD3	47		
HD4	48		
HD5	49		
Heavy Lip Close Needle	117		
Helicopter Sleeves And Beads	123		

M		P	
Magnum 5 Season	16	Pneumatic Aluminium Bait Gun	145
Magnum Air-Line Bed	7	PODS	62
Magnum Bed	6	PODS & BANKWARE	51
Magnum Carryall M/L/XL	22	POINT OF SALE DISPLAY UNITS	152
Magnum Deluxe Chair	9	Pop-Up Mat	82
Magnum High-Back Chair	9	Pop-Up Pegs	126
Magnum Multi Sleeves	20	POP-UP PEGS & PINS	126
MAGNUM RODS	70	Prodding Stick	96
Magnum Soft Sleeve	20	PROTECTION MESH	140
Magnum Spod & Marker	74	Protection Mesh Tube	140
Magnum Thermal Bed Cover	17	PULL & STRIP TOOL	120
Magnum X1	70	Pump Boat And Float Tube	94
Magnum X3	71	PVA & PROTECTION MESH	135
Magnum X5	72	PVA Bag Swivel	129
Magnum XLR	73	PVC Throwing Stick	142
MAINLINE, LEADERS & HOOKLINKS	105	Q	
Manual Aluminium Bait Gun	145	QC Rolling Swivel	128
MARKERS	143	QC Rolling Swivel with Ring	128
MESHES	79	Quick Clip	129
Metal Bait Crusher	142	Quick Lock Swivel	128
Metallic Display	153	R	
Metallic Lead Clips	122	Razor Point Hooks	98
Method Feeder	134	Razor Point Ready Rigs	102
Mini Carryall	23	Re-Action™	114
Mini Dolmen	35	READY RIGS	102
MONOFILAMENT MAINLINE	106	Remote LED Bivvy Light	150
Monster Barrow	26	Repairing Kit Boat And Float Tube	94
M-TX™	106	Replacement Meshes	79
Multi Carryall	22	Rig Ring Stop	126
N		RIG TOOLS	116
Net Protection	140	Riga-Mortis™	113
No Stress Cradle	81	Rigid Bag	20
O		Rod End Protector	21
One Piece Scoop	142	ROD HOLDALLS	19
Opti-Mex™	112	Rod Rest	61
Out House	36	Rod Sleeve	20
Oval Rings	129	RODS	65
		Rolling Swivel	128
		Rolling Swivel with Ring	128
		Rolling Swivel with Speed Link	128
		Round Rings	129
		Rubber Beads	123

S			
Safety Mat	82	Stick & String Needle Set	118
Safety Tube And Float Tube	95	Strip-Eaze Tool	120
Scale Tripod	84	SWIVELS & RINGS	128
SCALES	84	T	
SCISSORS & PLIERS	120	Tackle Box Set	151
SCS+	38	TACKLE BOXES	151
Seat	94	TERMINAL TACKLE	122
Set of 4 Pop-Up/Dip Pots	144	TERMINAL TACKLE, SWIVELS & LEADS	121
SHELTERS	37	THROWING STICKS	142
SHOCKLEADERS	109	TRANSPORT	26
Shrink Tube	124	TRIPOD	84
Shrink Wrap Boilie Guard	140	Tripod Bucket Stand	144
Silicone Tube	124	T-Shirts	147
Single Terminal Tackle Box	150	TUBBING & KICKERS	124
Sinking Rig Tube	124	Tungsten Hooklink Weights	124
SLEEPING BAGS	12	Tungsten Putty	125
SLEEPING BAGS & ACCESSORIES	11	Tungsten Tube	125
SLEEVES AND BEADS	123	U	
SLINGS AND SACKS	82	UNHOOKING MATS	81
Snag Ears	50	V	
SOLURON	136	Valve And Float Tube	95
Soluron Loader Bags	138	Velocity™ Tapered leader	109
Soluron PVA 3 In 1 Tube	136	Velocity™ XS	106
Soluron PVA Bag Funnel Loader	138	W	
Soluron PVA Bags	138	Water Scanner	96
Soluron PVA Bags & String	138	Waterproof Box	23
Soluron PVA Loader Starter Pack	138	WEIGHING	84
Soluron PVA String	136	X	
Soluron PVA Tape	136	X7 Swing Arm	50
Soluron PVA Tube	136	Z	
Soluron PVA Tube Refill	136	Zig-Master™	11
Speed-R	39		
Spod & Marker Braid™	108		
Spools Case	25		
Static Marker	143		
Stick & String Needle	117		





CSC

CLASSIC HAIR RIG

- Set of 2 hair rigs.
- Available in braided or fluorocarbon version.



CLASSIC FLUORO RIG



DISTANCE RIG

- Available in 2 sizes (70g and 90g).
- Lead core 100cm.
- Trilobe lead.
- Plastic lead clip.
- Rolling swivel.



NEEDLE KIT

- Pack of 3 needles including: 1 x Boilie Needle, 1 x PVA Needle and 1 x Seed Needle.



CATAPULT



BAITING KIT

Kit is composed of:

- Slingshot.
- Boilie catapult.
- Bait rocket.
- Marker.



ALU THROWING STICK

- Aluminium throwing stick.
- 2 diameters available; designed for the boilies up to 25mm.
- Ergonomic handle.



PVC THROWING STICK

- PVC throwing stick.
- 2 diameters available; designed for the boilies up to 30mm.
- Ergonomic handle.



CODE	SIZE (G)	BREAKING STRAIN (LBS)	HOOK SIZE	BAIT UP TO (MM)	QUANTITY	BARCODE	TRADE PACK
CLASSIC HAIR RIG							
155300361	—	25	1	—	2		10
155400361	—	25	2	—	2		10
155500361	—	25	4	—	2		10
155600361	—	25	6	—	2		10
ACC090000	—	25	8	—	2		10
CLASSIC FLUORO RIG							
157400361	—	25	4	—	2		10
157500361	—	25	6	—	2		10
DISTANCE RIG							
ACC090002	70	25	2	—	1		10
ACC090003	70	25	4	—	1		10
ACC090004	70	25	6	—	1		10
ACC090006	90	25	2	—	1		10
ACC090007	90	25	4	—	1		10
NEEDLE KIT							
ACC010000	—	—	—	—	—		1
CATAPULT							
142300360	—	—	—	—	1		3
BAITING KIT							
ACC010001	—	—	—	—	1		1
ALU THROWING STICK							
ACC010043	—	—	—	16-20	1		1
ACC010044	—	—	—	21-25	1		1
PVC THROWING STICK							
142400360	—	—	—	16-20	1		1
142500360	—	—	—	26-30	1		1

PACK ROD POD

Set includes:

- 1 rod pod.
- 3 rear heads.
- 3 blue alarms.
- 3 chain hangers.
- Supplied with transport bag.

Requires 1 battery V23GA not supplied.

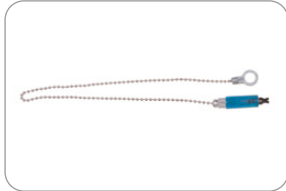

PACK ROD POD SESSION

- Tilt forward / backward.
- 360° rotatable.
- Telescopic legs.
- Usable as 3 or 4 rod set up.
- Supplied with transport bag.



Bag Included



ROD POD STABLE

- Adjustable double centre bar for stability.
- Telescopic legs.
- Compact when folded.
- Supplied with transport bag.



Bag Included



ALARM SET

Suitable for carp and predator fishing.

Set include:

- 2 aluminium bora point bank sticks (60/90).
- 1 blue alarm.
- 1 battery V23 GA.
- 1 U head rest.
- 1 chain hanger – blue.



SOFT HEAD



RIGID HANGER SET

- Available in 3 colours: Blue, Red and Yellow.



SOFT HANGER SET

- Adjustable fixing.
- Set of 3 colours: Blue, Red and Yellow.

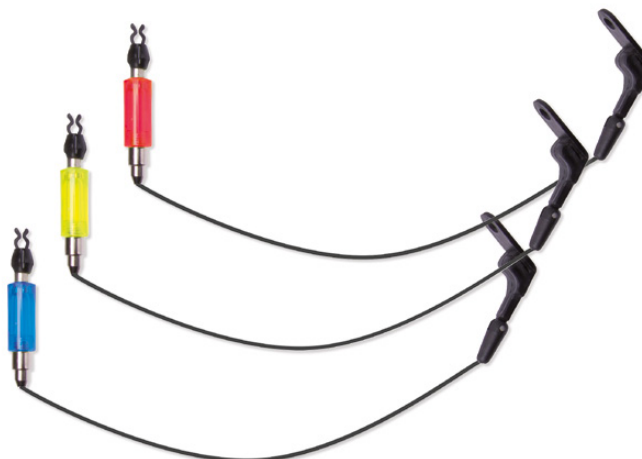

CODE	COLOUR	RODS	WEIGHT (KG)	QUANTITY	BARCODE	TRADE PACK
PACK ROD POD						
ACC370003	—	—	3.0	—		1
PACK ROD POD SESSION						
ACC370018	—	3/4	3.0	—		1
ROD POD STABLE						
ACC370021	—	2/3	1.70	—		1
ALARM SET						
ACC490020	—	—	—	—		1
SOFT HEAD						
ACC370023	Black	—	—	1		3
ACC370024	Luminous	—	—	1		3
RIGID HANGER SET						
ACC490002	Blue, Red, Yellow	—	—	1		3
SOFT HANGER SET						
ACC490001	Blue, Red, Yellow	—	—	3		3

BED CHAIR 6 LEGS

- 6 telescopic legs.
- Large feet.
- Safety clips.
- Steel framework.
- Quilted fabric (500D).
- Built-in mud protector.
- Maximum load 125kg.



MINI LANTERN

- For internal and external use.
- Running time about 20 hours without interruption.
- Requires 4 batteries AA (not supplied).



The handy flap handle for hanging or carrying the lamp

12 led for the optimal illumination

Made of shock resistant Plastic

On / off switch

Indicator requires 4 batteries AA (not supplied)

PADDED ROD HOLDALL

- Canvas Padded Rod Holdall (500D material).
- Quilted rod divider.
- Large reel pockets.
- Bait alarm pockets.
- Umbrella pocket.
- Rod pod pocket.



LANDING NET

- Fiberglass handle and arm.



PADDED LEVEL CHAIR WITH ARMS

- Premium range chair.
- Steel framework.
- 4 telescopic feet.
- Big feet.
- Safety clips
- Quilted fabric 500D with large edges.
- Maximum load 100kg.



LEVEL CHAIR

- Steel framework.
- 4 telescopic legs.
- Large feet.
- Safety clips.
- Quilted fabric (500D).
- Maximum load 100kg.



LEVEL CHAIR WITH ARMS

- Level chair with armrest.
- Steel framework.
- 4 telescopic legs.
- Large feet.
- Safety clips.
- Quilted fabric (500D).
- Maximum load 100kg.



LOUNGE CHAIR

- Compact design.
- Supplied with outer carry bag.



CODE	RODS	DIMENSIONS (CM) HxWxD	WEIGHT (KG)	BARCODE	TRADE PACK
BED CHAIR 6 LEGS					
147500360	—	201 x 74	9.8		1
MINI LANTERN					
ACC380000	—	0.28			1
PADDED ROD HOLDALL					
144400360	13' 4 Rod	212(L) x 38(W)	2.69		1
LANDING NET					
ACC180000	—	180(L) x 100(W) x 80(D)	—		1
PADDED LEVEL CHAIR WITH ARMS					
ACC520008	—	85 x 51 x 46	6.5		1
LEVEL CHAIR WITH ARMS					
ACC520009	—	70 x 48 x 40	5.5		1
LEVEL CHAIR					
ACC520010	—	70 x 48 x 40	4.0		1
LOUNGE CHAIR					
ACC520012	—	83 x 55 x 41	4.0		1

WEIGHT / STORAGE FLOATING BAG

- Designed to weigh and store the fish in the best conditions.
- Drainage sides for a better circulation of water.
- Full zip allowing full opening bag with safety clip.
- Equipped with floats to keep the bag at surface.
- Supplied with carrying bag.



CARP MAT

- Folding unhooking mat.
- Elastic straps to secure.



PVC MAT





- Folding unhooking mat.
- Fitted with 4 rings to peg to floor.
- Elastic straps to secure.



TROLLEY

- A lightweight, space-saving trolley designed to transport your equipment wherever your vehicle cannot go.
- Delivered with 2 elastic straps with hooks.
- Storage cover on the front.
- Mounted trolley dimensions: 140 x 60 x 66cm.
- Maximum load 100kg.



CODE	DIMENSIONS (CM)	WEIGHT (KG)	BARCODE	TRADE PACK
WEIGHT / STORAGE FLOATING BAG				
ACC070007	120(H) x 65(W)	0.9		1
PVC MAT				
ACC070010	85(L) x 45(W)	—		1
CARP MAT				
ACC070002	115(L) x 65(W)	—		1
TROLLY				
ACC070008	—	6.5		1
ACC070009 (Spare Wheel)	—	1.10		1

INDEX

B

Baiting Up	159
Bed Chair	162
Bobbins And Bite Indication	161

C

Carp Care	164
Catapults	159
Chairs	163
Classic Fluoro Rig	158
Classic Hair Rig	158

D

Distance Rig	158
--------------	-----

L

Landing Net	162
Lighting	162

N

Needles	158
---------	-----

R

Ready Rigs	158
Rod Holdalls	162
Rod Pod	160
Rod Rests	161

T

Throwing Sticks	159
Trolley	164





